

2000 VOLVO S & V70

This manual deals with the operation and care of your Volvo.



Welcome to the world-wide family of Volvo owners. We trust that you will enjoy many years of safe driving in your Volvo, an automobile designed with your safety and comfort in mind. To help ensure your satisfaction with this vehicle, we encourage you to familiarize yourself with the equipment descriptions, operating instructions and maintenance requirements/recommendations in this manual. We also urge you and your passengers to wear seat belts at all times in this (or any other) automobile. And, of course, please do not operate a vehicle if you may be affected by alcohol, medication or any impairment that could hinder your ability to drive.

Your Volvo is designed to meet all applicable safety and emission standards, as evidenced by the certification labels attached to the driver's door opening and on the left wheel housing in the engine compartment.

For further information please contact your retailer, or:

In the USA: In Canada:

Volvo Cars of North America Volvo Canada Ltd.

Customer Relations 175 Gordon Baker Road

P.O. Box 914 Willowdale, Ontario M2H 2N7

Rockleigh, New Jersey 07647-0914 800-663-8255

800-458-1552

We also invite you to visit our Home Page on the Internet at:

<http://www.volvocars.com>

Contents

Contents

[Chapter 1 - Occupant safety](#)

[Chapter 2 - Instruments, switches and controls](#)

[Chapter 3 - Body and interior](#)

[Chapter 4 - Starting and driving](#)

[Chapter 5 - Wheels and tires](#)

[Chapter 6 - In case of an emergency](#)

[Chapter 7 - Car care](#)

[Chapter 8 - Volvo Service](#)

[Chapter 9 - Specifications](#)

[Chapter 10 - Audio systems](#)

[HomeLink® Universal Transceiver \(option\)](#)

[Index](#)

General information

Important

Before you operate your car for the first time, please familiarize yourself with the BREAK-IN information on page 66. You should also be familiar with the information in the first three

chapters of this manual.

Information contained in the balance of the manual is extremely useful and should be read after operating the vehicle for the first time.

The manual is structured so that it can be used for reference. For this reason, it should be kept in the car for ready access.

Do not export your Volvo to another country before investigating that country's applicable safety and exhaust emission requirements. In some cases it may be difficult or impossible to comply with these requirements. Modifications to the emission control system(s) may render your Volvo not certifiable for legal operation in the U.S., Canada and other countries.

All information, illustrations and specifications contained in this manual are based on the latest product information available at the time of publication. Please note that some vehicles may be equipped differently, depending on special legal requirements and that optional equipment described in this manual may not be available in all markets.

Volvo reserves the right to make model changes at any time, or to change specifications or design, without notice and without incurring obligation.

CAUTION: Certain models have reduced ground clearance due to the design of the front spoiler. Please observe caution when e.g., driving onto garage hoists, through drifted snow or when other road debris is encountered, or when parking near curbs.

© 1998 Volvo Cars of North America Inc.

Shiftlock (automatic transmission only)

When your car is parked, the gear selector is locked in the (P)ark position. To release the selector from this position, turn the ignition key to position II (or start the engine), depress the brake pedal, press the button on the front side of the gear selector and move the selector from (P)ark.

If it is necessary to manually override the shiftlock system:

- Turn the starting (ignition) key to position I
- Press firmly on the "SHIFTLOCK OVERRIDE" button located to the right of the base of the gear selector
- While holding the override button down, press the button on the front of the gear selector
- Move the selector from the (P)ark position.

Keylock (automatic transmission only)

This means that when you switch off the ignition, the gear selector must be in the (P)ark position before the starting (ignition) key can be removed from the ignition switch.

Clutch interlock (manual transmission only)

The clutch must be fully depressed before you can start your car. If the clutch is not depressed, it will not be possible to start the engine.

Anti-lock Brake System (ABS)

The ABS system in your car performs a self-diagnostic test when the vehicle first reaches the speed of approximately 12 mph (20 km/h). The brake pedal will pulsate several times and a sound may be audible from the ABS control module. This is normal.

Fuel tank cover

The fuel tank cover is locked and must be popped open using the control on the driver's door (see illustration on [page 16](#)).

Volvo and the environment

Volvo is committed to the well being of our customers. As a natural part of this commitment, we care about the environment in which we all live. Caring for the environment means an everyday involvement in reducing our environmental impact.

Volvo's environmental activities are based on a holistic view, which means we consider the overall environmental impact of a product throughout its complete life cycle. In this context, design, production, product use, and recycling are all important considerations.

In production, Volvo has partly or completely phased out several chemicals including freons, lead chromates, naphthanates, asbestos, mercury and cadmium; and reduced the amount of chemicals used in our plants 50% since 1991.

In use, Volvo was the first in the world to introduce into production a three-way catalytic converter with a Lambda sond, now called oxygen sensor, in 1976. The current version of this highly efficient system reduces emissions of harmful substances (CO, HC, NOx) from the exhaust pipe by approximately 95% and the search to eliminate the remaining emissions continues. Volvo is the only automobile manufacturer to offer CFC-free retrofit kits for the air conditioning system for all models as far back as the M/Y 1975 240. Advanced electronic engine controls, refined purification systems and cleaner fuels

are bringing us closer to our goal.

After Volvo cars and parts have fulfilled their use, recycling is the next critical step in completing the life cycle. The metal content is about 75% of the total weight of a car, which makes the car among the most recycled industrial products. In order to have efficient and well controlled recycling, many Volvo variants have printed dismantling manuals, indicating the weight and material of individual components. For Volvo, all homogeneous plastic parts weighing more than 1.7 oz. (50 grams) are marked with international symbols that indicate how the component is to be sorted for recycling.

In addition to continuous environmental refinement of conventional gasoline-powered internal combustion engines, Volvo is actively looking at advanced technology alternative-fuel vehicles.

When you drive a Volvo, you become our partner in the work to lessen the car's impact on the environment.

To reduce your vehicle's environmental impact, you can:

- Maintain proper air pressure in your tires. Tests have shown decreased fuel economy with improperly inflated tires
- Follow the recommended maintenance schedule
- Drive at a constant speed
- See an authorized Volvo retailer as soon as possible for inspection if the check engine (malfunction indicator) lamp illuminates, or stays on after the vehicle has started
- Properly dispose of any vehicle related waste such as used motor oil, used batteries, brake pads, etc.
- When cleaning your car, use Volvo's own car care products, all of which have systematically been adapted to the environment

For additional information regarding the environmental activities in

which Volvo Cars of North America, Inc. and Volvo Car Corporation are involved, visit our Internet Home Page at:

<http://www.volvocars.com>

Three-way catalytic converter

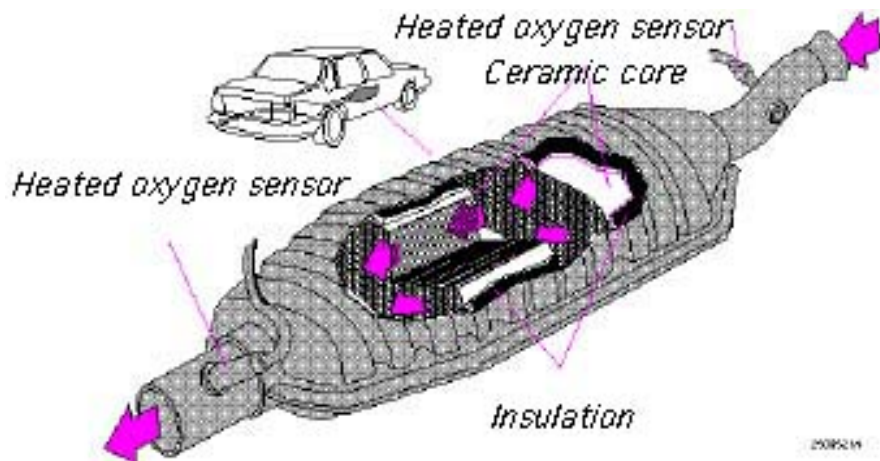

Three-way catalytic converter cautions

- Keep your engine properly tuned. Certain engine malfunctions, particularly involving the electrical, fuel or distributor ignition systems, may cause unusually high three-way catalytic converter temperatures. **Do not continue to operate your vehicle if you detect engine misfire, noticeable loss of power or other unusual operating conditions, such as engine overheating or backfiring.** A properly tuned engine will help avoid malfunctions that could damage the three-way catalytic converter.
- Do not park your car over combustible materials, such as grass or leaves, which can come into contact with the hot exhaust system and cause such materials to ignite under certain wind and weather conditions.
- Excessive starter cranking (in excess of one minute), with an intermittently firing or flooded engine, can cause three-way catalytic converter or exhaust system overheating.
- Remember that tampering or unauthorized modifications to the engine or the vehicle may be illegal and can cause three-way catalytic converter or exhaust system overheating. This includes:
 - Altering fuel injection setting or components.
 - Altering emission system components or location or removing components.
 - Repeated use of leaded fuel.

NOTE: Unleaded fuel is required for cars with three-way catalytic converters.



[Top of Page](#)

2000 VOLVO S & V70

Chapter 1 - Occupant safety

pg. 1 Occupant safety

Despite our strongest recommendations, and your best intentions, not wearing a seat belt is like believing "It'll never happen to me!". Volvo, the inventor of the three-point seat belt, urges you and all adult occupants of your car to wear seat belts and ensure that children are properly restrained, using an infant, car or booster seat determined by age, weight and height. Volvo also believes no child should sit in the front seat of a car.

Fact: In every state and province, some type of child-restraint legislation has been passed. Additionally, most states and provinces have already made it mandatory for occupants of a car to use seat belts.

So, urging you to "buckle up" is not just our recommendation - legislation in your state or province may mandate seat belt usage. The few seconds it takes to buckle up may one day allow you to say, "It's a good thing I was wearing my seat belt".



[Seat belts](#) [2](#)

[Volvo SRS](#) [4](#)

[Side Impact Protection System - \(SIPS\) air bag](#) [8](#)

[Whiplash Protection System \(WHIPS\)](#) [9](#)

[Child safety](#) [10](#)

[Occupant safety](#) [16](#)

[Reporting Safety Defects](#) [16](#)

Seat belts

Always fasten the seat belts before you drive or ride.

Two lights above the rear view mirror will be illuminated for 4-8 seconds after the starting (ignition) key is turned to the driving position. A chime will sound at the same time if the driver has not fastened his seat belt. The rear seats are provided with self-retracting inertia reel belts. The front seats are provided with single roller belts with tensioners.

To buckle:

Pull the belt out far enough to insert the latch plate into the receptacle (buckle for rear seats)

until a distinct snapping sound is heard. The seat belt retractor is normally "unlocked" and

you can move freely, provided that the shoulder belt is not pulled out too far. The retractor will lock up as follows:

- if the belt is pulled out rapidly
- during braking and acceleration
- if the vehicle is leaning excessively
- when driving in turns

For the seat belt to provide maximum protection in the event of an accident, it must be worn correctly.

When wearing the seat belt remember:

- The belt should not be twisted or turned.
- The lap belt must be positioned low on the hips (not pressing against the abdomen).
- The shoulder section of the front seat belts adjusts automatically to the driver's height.

Make sure that the shoulder belt is rolled up into its retractor and that the shoulder and lap

belts are taut.

Before exiting the car, check that the seat belt retracts fully after being unbuckled.

If necessary, guide the belt back into the retractor slot.

NOTE: Legislation in your state or province may mandate seat belt usage.

Adjusting the shoulder belt

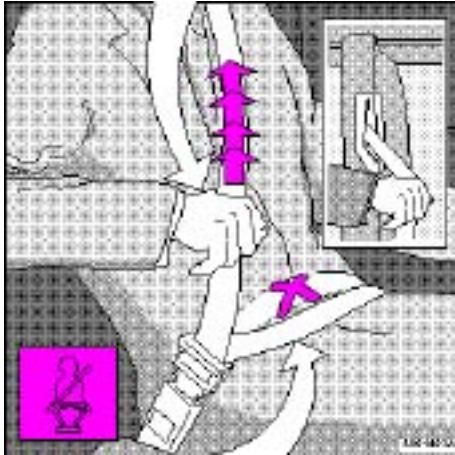

Lap portion of the seat belt should sit low

WARNING!

Any device used to induce slack into the shoulder belt portion of the three-point belt system will have a detrimental effect on the amount of protection available to you in the event of a collision. The seat back should not be tilted too far back. The shoulder belt must be taut in order to function properly.

Spool-out

To make child seat installation easier, each seat belt buckle (except for the driver's belt) is equipped with a locking mechanism to help keep the lap section of the seat belt taut. Please refer to page 13 for more information on this function.

WARNING!

Do not use child safety seats or child booster cushions/backrests in the front passenger's seat. We also recommend that children who have outgrown these devices sit in the rear seat with the seat belt properly fastened.

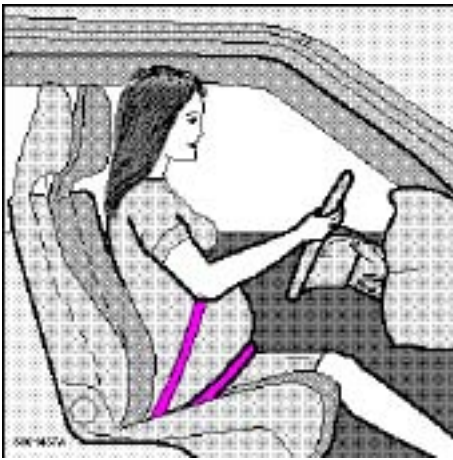

During pregnancy

Pregnant women should always wear seat belts. Remember that the belt should always be positioned in such a way as to avoid any possible pressure on the abdomen. The lap portion of the belt should be located low, as shown in the above illustration.

WARNING!

Never use a seat belt for more than one occupant. Never wear the shoulder

portion of the belt under the arm, behind the back or otherwise out of position. Such use could cause injury in the event of an accident. As the seat belts lose much of their strength when exposed to violent stretching, they should be replaced after any collision, even if they appear to be undamaged. Never repair the belt on your own; have this work done by an authorized Volvo retailer only.

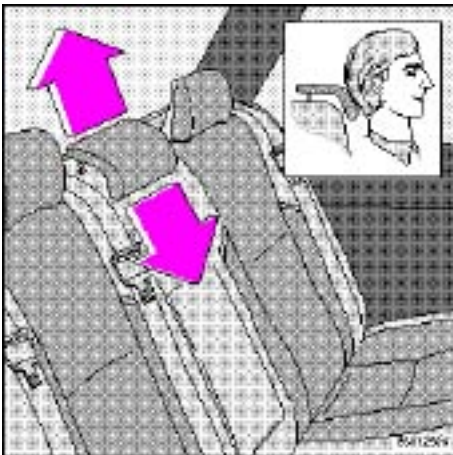

Center head restraint

The center head restraint can be adjusted according to the passenger's height. The restraint should be carefully adjusted to support the occupant's head.

To raise: Pull straight up

To lower: Pull forward and push down

pg. 4 Volvo SRS

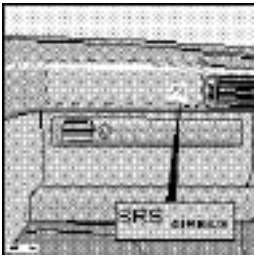
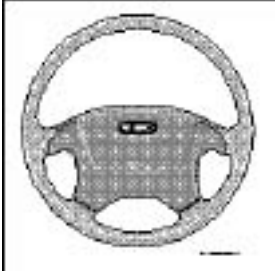

Passenger side SRS hatch

As an enhancement to the three-point seat belt system, your Volvo is equipped with a Supplemental Restraint System (SRS). The Volvo SRS consists of an airbag (2) on both the driver's and passenger's sides and seat belt tensioners in both front door pillars (4). The system is designed to supplement the protection provided by the three-point seat belt system.

The SRS system is indicated by the "SRS" embossed on the steering wheel pad and above the glove compartment, and by decals on both sun visors and on the far right side of the dash.

The airbags are folded and located in the steering wheel hub and above the glove compartment. They are designed to deploy during certain frontal or front-angular collisions, impacts, or decelerations, depending on the crash severity, angle, speed and object impacted. The airbags may also deploy in certain non-frontal collisions where rapid deceleration occurs.

The airbag system includes gas generators (1) surrounded by the airbags (2) and front seat belt tensioners for both of the front seats (4). To deploy the system, the sensor (3) activates the gas generators causing the airbags to be inflated with nitrogen gas. As the movement of the seats' occupants compresses the airbags, some of the gas is expelled at a controlled rate to provide better cushioning. Both seat belt tensioners also deploy, minimizing any seat belt slack.

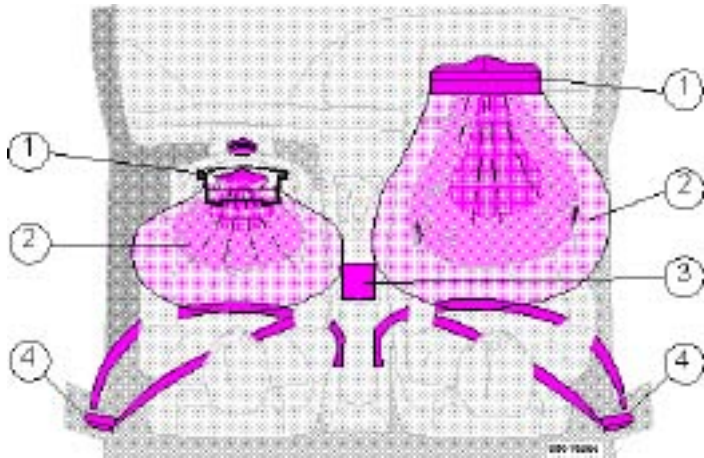

The entire process, including inflation and deflation of the airbags, takes approximately two-tenths of a second.

WARNING!

- As its name implies, SRS is designed to be a **SUPPLEMENT** to - not a replacement for - the three-point belt system. For maximum protection, wear seat belts at all times. Be aware that no system can prevent all possible injuries that may occur in an accident.
- When installing any optional equipment, make sure that the SRS system is not damaged. Do not attempt to service any component of the SRS yourself. Attempting to do so may result in serious personal injury. If a problem arises, take your car to the nearest authorized Volvo retailer for inspection as soon as possible.

pg. 5 Volvo SRS

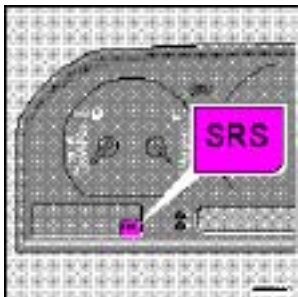

A self-diagnostic system incorporated in the sensor monitors the SRS. If a fault is detected, the "SRS" warning light will illuminate. The light is included in the warning/indicator light cluster in the instrument panel. Normally, the SRS warning lamp should light up when the ignition is switched on and should go out after 5 seconds or when the engine is started. Check that this light is functioning properly every time the car is started.

The following items are monitored by the self-diagnostic system:

airbags and seatbelt tensioners. This service must be performed by an authorized Volvo retailer.

Should you have any questions about the SRS system, please contact

your authorized Volvo retailer or Volvo Customer Support:

Customer Relations

In the USA:

Volvo Cars of North America
175 Gordon Baker Road
P.O. Box 914
Rockleigh, New Jersey 07647-0914
800-458-1552

In Canada:

Volvo Canada Ltd.
Willowdale, Ontario M2H 2N7
800-663-8255

pg. 6 Volvo SRS



SRS texts on inside of both sun visors



SRS texts on outside of both sun visors



SRS texts on the passenger's dash



SRS text at far right of instrument panel

WARNING!

Do not use child safety seats or child booster cushions/backrests in the front passenger's seat. We also recommend that children who have outgrown these devices sit in the rear seat with the seat belt properly fastened.

NOTE: Deployment of SRS components occurs only one time during an accident. In a collision where deployment occurs, the air bags and seat belt tensioners activate. Some noise occurs and a small amount of powder is released. The release of the powder may appear as smoke-like matter. This is a normal characteristic and does not indicate fire.

NOTE: NOTE: Volvo's dual-threshold air bags use special sensors that are integrated with the front seat buckles. The point at which the air bag deploys is determined by whether or not the seat belt is being used, as well as, the severity of the collision. Collisions can occur where only one of the airbags deploys.

WARNING!

- Children must never be allowed in the front passenger seat. Volvo recommends that ALL occupants (adults and children) shorter than 4 feet 7 inches (140 cm) be seated in the back seat of any vehicle with a front passenger side airbag. See page 12 for guidelines.
- Occupants in the front passenger's seat must never sit on the edge of the seat, sit leaning toward the instrument panel or otherwise sit out of position. The occupant's back must be as upright as comfort allows and be against the seat back with the seat belt properly fastened.
- Feet must be on the floor, e.g. not on the dash, seat or out of the window.
- No objects or accessory equipment, e.g. dash covers, may be placed on, attached to or installed near the SRS hatch (the area above the glove compartment) or the area affected by airbag deployment (see illustration).
- There should be no loose articles, e.g. coffee cups, on the floor, seat or dash area.
- Never try to open the SRS cover on the steering wheel or the passenger side SRS seam. This should only be done by an authorized Volvo service technician.
- Failure to follow these instructions can result in injury to the vehicle occupants in an accident.

NOTE: The information on this page does not pertain to the Side Impact Protection System airbags.

When are the airbags deployed? The SRS system is designed to deploy during certain frontal or frontangular collisions, impacts, or decelerations, depending on the crash severity, angle, speed and object impacted. The SRS sensor is designed to react to both the impact of the collision and the inertial forces generated by it and to determine if the intensity of the collision is sufficient for the airbags to be deployed.

WARNING!

The SRS is designed to help prevent serious injury. Deployment occurs very quickly and with considerable force. During normal deployment and depending on variables such as seating position, one may experience abrasions, bruises, swellings, or other injuries as a result of airbag(s) deployment.

If the airbags have been deployed, we recommend the following:

- Have the car towed to an authorized Volvo retailer. Never drive with the airbags deployed.
- Have an authorized Volvo retailer replace the SRS system components.
- Use only new, Genuine Volvo Parts when replacing SRS components (airbags, seat belts, tensioners, etc.).

When are the airbags NOT deployed?

Not all frontal collisions activate the SRS system. If the collision involves a nonrigid object (e.g., a snow drift or bush), or a rigid, fixed object at a low speed, the SRS system will not necessarily deploy. Front airbags do not normally deploy in a side impact collision, in a collision from the rear or in a rollover situation. The amount of damage to the bodywork does not reliably indicate if the airbags should have deployed or not.

Seat belts the heart of the Volvo safety system

The heart of the Volvo safety system is the **threepoint seat belt** (a Volvo invention)! In order for the SRS system to provide the protection intended, seat belts must be worn at all times by everyone in the car.

The SRS system is a supplement to the seat belts.

WARNING!

If your car has been subjected to flood conditions (e.g. soaked carpeting/standing water on the floor of the vehicle) or if your car has become flooddamaged in any way, do not attempt to start the vehicle or put the key in the ignition before disconnecting the battery (see below). This may cause airbag deployment which could result in personal injury. Have the car towed to an authorized Volvo retailer for repairs.

Automatic transmission only:

Before attempting to tow the car, use the following procedure to override the shiftlock system to move the gear selector to the neutral position.

- Disconnect the battery
- Wait at least one minute
- Insert the key in the ignition and turn it to position 1
- Press firmly on the shiftlock override button (located near the base of the gear selector).
- While holding the override button down, move the gear selector from the park position.

WARNING!

Never drive with the airbags deployed. The fact that they hang out can impair the steering of your car. Other safety systems can also be damaged. The smoke and dust formed when the airbags are deployed can cause skin and eye irritation in the event of prolonged exposure.

pg. 8 Volvo Side Impact Protection System (SIPS) airbag



1 - Airbag, 2 - cable, 3 - sensor unit,

SIPS airbag

As an enhancement to the structural Side Impact Protection System built into your car, the car is also equipped with Side Impact Protection System (SIPS) airbags. The SIPS airbag system consists of airbag modules built into the sides of both front seat backrests (1), cables (2) from these modules to the electronic sensor units (3).

The SIPS airbag system is designed to help increase occupant protection in the event of certain side

impact collisions. The SIPS airbags are designed to deploy only during certain side impact collisions, depending on the crash severity, angle, speed and point of impact. The airbags are not designed to deploy in all side impact situations.

NOTE: SIPS airbag deployment (one airbag) occurs only on the side of the vehicle affected by the impact.

WARNING!

- The SIPS airbag system is a supplement to the Side Impact Protection System and the three-point seat belt system. It is not designed to deploy during collisions from the front or rear of the car or in rollover situations.
- The use of seat covers on the front seats may impede SIPS airbag deployment.
- No objects, accessory equipment or stickers may be placed on, attached to or installed near, the SIPS airbag system or in the area affected by SIPS airbag deployment (see illustration to the right above).
- Never try to open or repair any components of the SIPS airbag system. This should only be done by an authorized Volvo service technician.
- For best protection from the SIPS airbag system, both front seat occupants should sit in an upright position with the seat belt properly fastened.

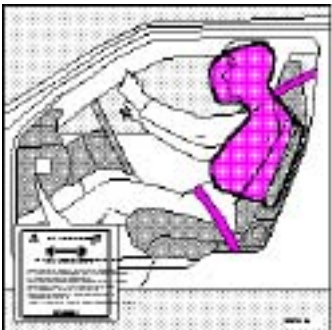

SIPS airbag decal

WARNING!

- Never drive with the airbags deployed. The fact that they hang out can impair the steering of your car. Other safety systems can also be damaged. The smoke and dust formed when the airbags are deployed can cause skin and eye irritation in the event of prolonged exposure.
- If your car has been subjected to flood conditions (e.g. soaked carpeting/standing water on the floor of the vehicle) or if your car has become flooddamaged in any way, do not attempt to start the vehicle or put the key in the ignition before disconnecting the battery. This may cause airbag deployment which could result in personal injury. Have the car towed to an authorized Volvo retailer for repairs.

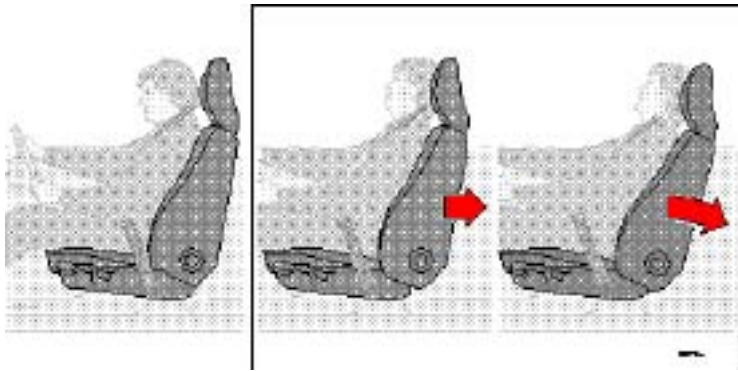

Whiplash Protection System (WHIPS) - front seats only

The WHIPS system consists of specially designed hinges and brackets on the front seat backrests and head restraints designed to help absorb some of the energy generated in a collision from the rear ("rear-ended").

In the event of a collision of this type, the hinges and brackets of the front seat backrests are designed to change position slightly to allow the backrest/head restraint to help support the occupant's head before moving slightly rearward. This movement helps absorb some of the forces that could result in the whiplash effect.

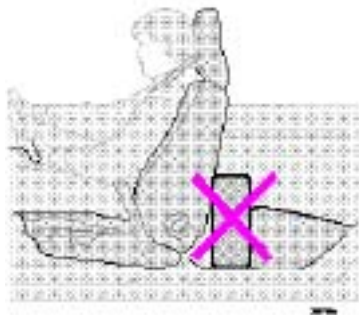

Do not wedge boxes, suitcases, etc. behind front seats

WARNING!

- Boxes, suitcases, etc. wedged behind the front seats (see illustration above) could impede the function of the WHIPS system.
- The WHIPS system is designed to supplement the other safety systems in your car. For this system to function properly, the three-point seat belt must be worn. Please be aware that no system can prevent all possible injuries that may occur in an accident.
- If your car has been involved in a collision, the front seat backrests must be inspected by an authorized Volvo retailer even if the seats appear to be undamaged. Certain components in the WHIPS system may need to be replaced. Do not attempt to service any component in the WHIPS system yourself.
- If the rear seat backrests are folded down, cargo must be secured to prevent it from sliding forward against the front seat backrests in the event of a collision from the rear. This could interfere with the action of the WHIPS system.
- The WHIPS system is designed to function in certain collisions from the rear, depending on the crash severity, angle and speed.
- Occupants in the front seats must never sit out of position. The occupant's back must be as upright as comfort allows and be against the seat back with the seat belt properly fastened.



[Contents](#) | [Top of Page](#)

2000 VOLVO S & V70

pg. 10 Child safety

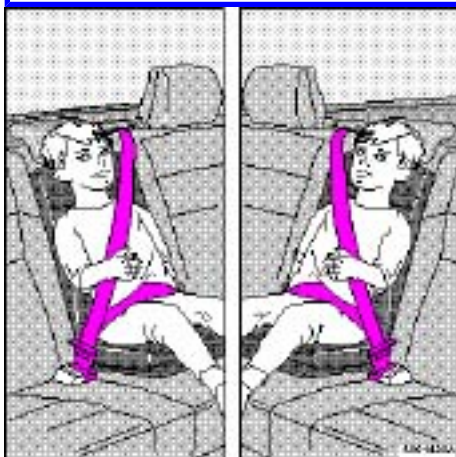

1 - Sedan

2 - Wagon

Integrated booster cushion-center position

Integrated booster cushions, center and outboard positions (optional)

Volvo's own integrated booster cushions have been specially designed to help safeguard a child seated in the rear seat. When using an integrated booster cushion, the child must be secured with the vehicle's three-point seat belt. The booster cushions are approved for children weighing between 33 and 80 lbs (15 and 36 kg) and between 38 and 54 in (97 and 137 cm) in height.

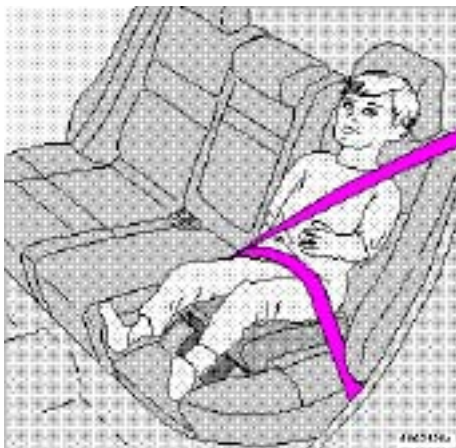

Integrated booster cushion - outboard positions

The child should be properly seated on the booster cushion. The head restraint should be carefully adjusted to support the child's head (only center position). The hip section of the threepoint seat belt must fit snugly across the child's hips, not across the stomach. The shoulder section of the threepoint seat belt should be positioned across the chest and shoulder (see illustration). The shoulder belt must never be placed behind the child's back or under the arm.

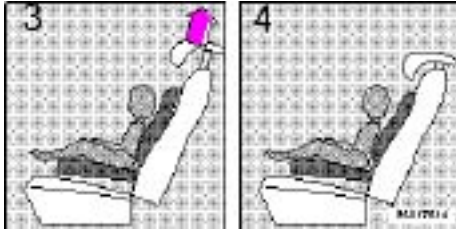

head restraint-center position

For small children, the booster cushion backrest can be tilted back slightly by raising the center head restraint above the upper edge of the booster cushion backrest (3) and tilting the backrest (4). For taller children, it is essential that the head restraint be adjusted properly to help support the child's head (see [page 3](#)).

pg. 11 Child safety

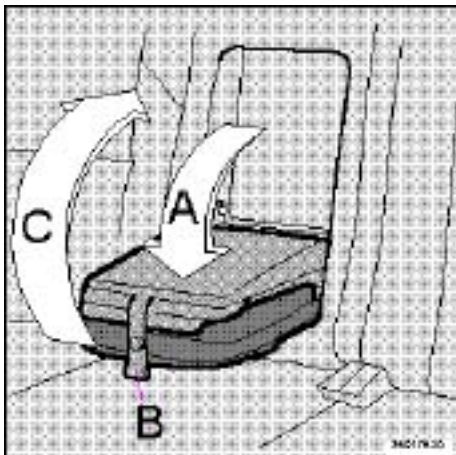

Integrated booster cushion-center position

Storing the center booster cushion

To store (fold up):

- Fold down the booster cushion backrest to the seat section (A)
- Snap the backrest snap to the fastener on the seat (B)
- Fold up the booster cushion unit (C)

NOTE: The booster cushion must be folded down as one unit. If the backrest is not strapped to the seat section of the cushion, the backrest hinges may lock.

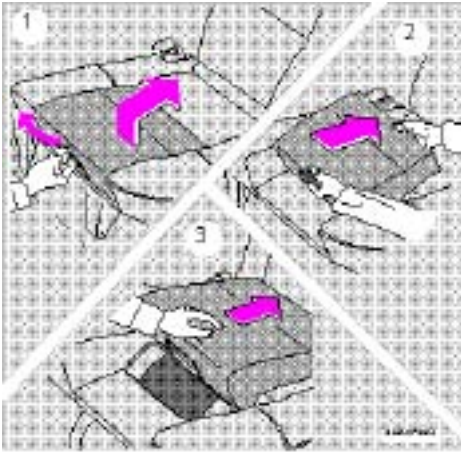

Integrated booster cushion - outboard positions

Outboard integrated booster cushions - Raising

1. Pull the handle at the front of the cushion forward.
2. With both hands push the cushion rearward.
3. Push the cushion until it locks in place.



Integrated booster cushion - outboard positions

Outboard integrated booster cushions - Lowering

1. Pull the handle at the front of the cushion forward.
2. Push the cushion forward/downward.

NOTE: The booster cushion must be completely lowered before the rear seat backrest can be folded down.

WARNING!

Failure to follow the instructions on these pages will increase the risk of your child being injured during a sudden stop or collision. In the event of a collision while the integrated booster cushion was occupied, the entire booster cushion and seat belt must be replaced. The booster cushion should also be replaced if it is badly worn or damaged in any way. This work should be performed by an authorized Volvo retailer only. The booster cushion should be cleaned while in place in the vehicle if possible. If not, please consult your Volvo retailer.

pg. 12 Child safety

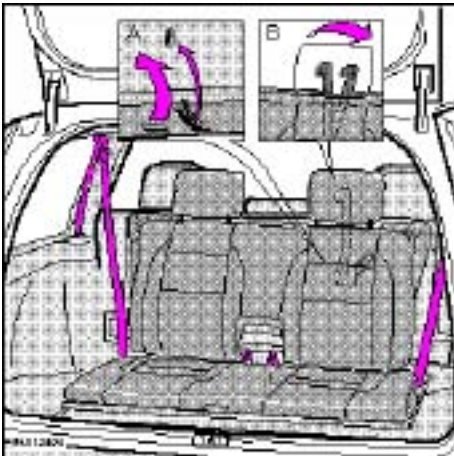

Auxiliary seat - A-fold up, B-fold down

Auxiliary seat (optional)

If all the seats are occupied, a rear-facing auxiliary seat in the cargo area of wagon models can be used.

This seat is designed for two children, each weighing between 50 - 88 lbs. (23 - 40 kg) with a total seat capacity of 176 lbs. (80 kg) and up to 59 inches (150 cm) in height.

WARNING!

Both rear seat backrests must be up when the auxiliary seat is being used. Do not use a booster cushion or child seat in conjunction with the auxiliary seat.

The luggage net should be retracted and the child safety lock in the tailgate should be open to allow access to the cargo area.



WARNING!

The exhaust pipe will still be hot when the engine is turned off. Take care that children do not burn themselves when they get into or out of the car.

pg. 13 Child safety

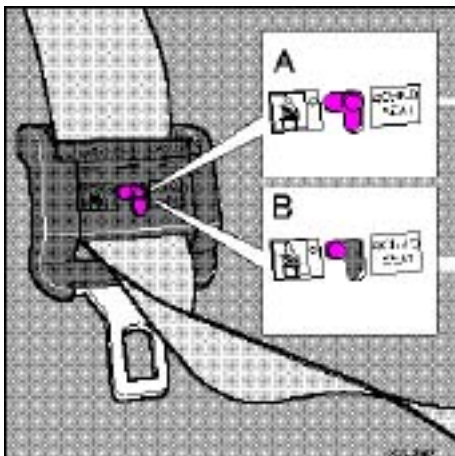

*A-Lap section of belt locked in place,
B-Lap section functions normally*

Keeping child seats in place (spool-out)

To make child seat installation easier, each seat belt buckle (except for the driver's belt) is equipped with a locking mechanism to help keep the lap section of the seat belt taut.

When attaching the seat belt to a child seat:

- Make sure the red lock button is moved to the right (see illustration A above). A coin, etc. can be used to move the button.
- Attach the seat belt to the child seat according to the child seat manufacturer's instructions.
- Pull the lap section of the seat belt taut.

The lap section of the seat belt cannot be loosened as long as the red lock button is in the right position. The lap section of the seat belt can be adjusted when the lock button is in the left position (see illustration B).

NOTE: Before exiting the car, check that the seat belt retracts fully after being unbuckled. If necessary, guide the belt back into the retractor slot. When not in use, the child restraint should be secured with the seat belt to help prevent movement during a sudden stop.

WARNING!

Do not use child safety seats or child booster cushions/backrests in the front passenger's seat. We also recommend that children who have outgrown these devices sit in the rear seat with the seat belt properly fastened.

Important!

Why Volvo believes no child should sit in the front seat of a car.

It's quite simple really. A front air bag is a very powerful device designed, by law, to help protect an adult. Because of the size of the air bag and its speed of inflation, a child should never be placed in the front seat, even if he or she is properly belted or strapped into a child safety seat. Volvo has been an innovator in safety for over fifty years, and we'll continue to do our part. But we need your help. Please remember to put your children in the back seat, and buckle them up.

Volvo has some very specific recommendations:

- Always wear your seat belt.
- Air bags are a SUPPLEMENTAL safety device which when used in conjunction with a three-point seat belt can help reduce serious injuries during certain types of severe accidents. Volvo recommends that you do not disconnect the air bag system in your vehicle.
- Volvo strongly recommends that ALL children sit in the rear seat of any vehicle and that they be properly restrained.
- A child should NEVER sit in the front passenger seat of any vehicle equipped with a front passenger side airbag.
- Volvo recommends that ALL occupants (adults and children) shorter than four feet seven inches (140 cm) be seated in the back seat of any vehicle with a front passenger side airbag.

Drive safely!

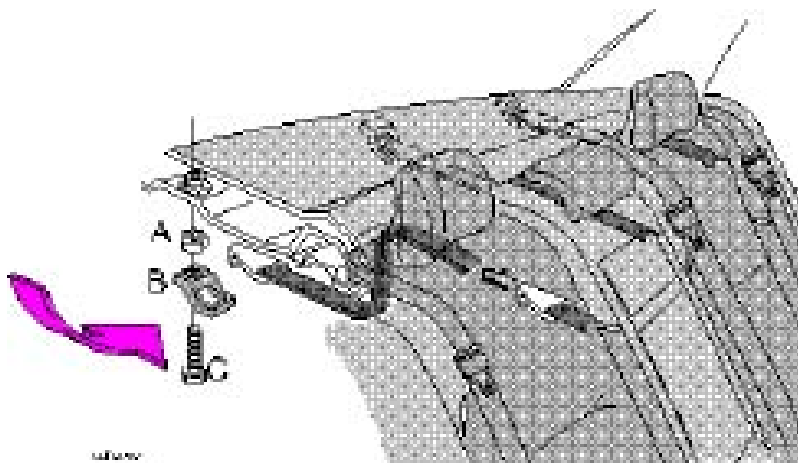

Sedan

Child Restraint Anchorages

Volvo cars can or are fitted with Child Restraint Top Tether Anchorages in the rear seat.

Sedans: There are three predrilled anchorage points under the rear window shelf which are not visible from the passenger compartment. **Wagons:** The anchorage points are on the rear seat backrest and are hidden by plastic covers. The backrest must be folded down to access the center anchorage point.

Wagon

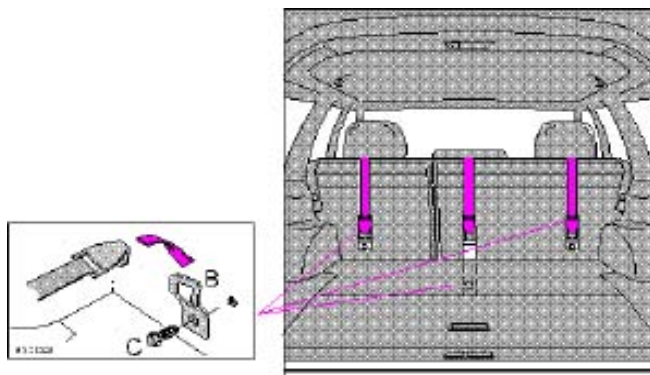

A 10 mm spacer, B anchorage plate, C 5/16" UNC bolt

Installing the top tether

Sedans: The predrilled holes for the child restraint anchorages are underneath the rear window shelf and can be accessed from the trunk or by lowering the rear seat backrests. **Wagons:** Remove the plastic cover from the anchorage point you intend to use.

On either model, refer to the child seat manufacturer's instructions for securing the seat.

WARNING!

Child Restraint Anchorages are designed to withstand only those loads imposed by correctly fitted Child Restraints. Under no circumstances are they to be used for adult seat belts or harnesses. The anchorages are not able to withstand excessive forces on them in the event of collision if full harness seat belts or adult seat belts are installed to them. An adult who uses a belt anchored in a Child Restraint Anchorage runs a great risk of suffering severe injuries should a collision occur. Do not install rear speakers which would require the removal of the top tether anchors or interfere with the proper use of the top tether strap.

pg. 15 Child safety

Child safety

Volvo recommends the proper use of restraint systems for all occupants including children. Remember that, regardless of age and size, a child should always be properly restrained in a car.

Restraint systems for children are designed to be secured in the vehicle by lap belts or the lap portion of a lapshoulder belt. Such child restraint systems can help protect children in cars in the event of an accident only if they are used properly. However, children could be endangered in a crash if the child restraints are not properly secured in the vehicle. Failure to follow the installation instructions for your child restraint can result in your child striking the vehicle's interior in a sudden stop.

Holding a child in your arms is NOT a suitable substitute for a child restraint system. In an accident, a child held in a person's arms can be crushed between the vehicle's interior and an unrestrained person. The child could also be injured by striking the interior, or by being ejected from the vehicle during a sudden maneuver or impact. The same can also happen if the infant or child rides unrestrained on the seat. Other occupants should also be properly restrained to help reduce the chance of injuring or increasing the injury of a child.

All states and provinces have legislation governing how and where children should be carried in a car. Find out the regulations

existing in your state or province. Recent accident statistics have shown that children are safer in rear seating positions than front seating positions when properly restrained. A child restraint system can help protect a child in a vehicle. Here's what to look for when selecting a child restraint system:

- It should have a label certifying that it meets applicable Federal Motor Vehicle Safety Standards (FMVSS 213) or in Canada, CMVSS 213.
- Make sure the child restraint system is approved for the child's height, weight and development the label required by the standard or regulation, or instructions for infant restraints, typically provide this information.

- **In using any child restraint system, we urge you to look carefully over the instructions that are provided with the restraint. Be sure you understand them and can use the device properly and safely in this vehicle. A misused child restraint system can result in increased injuries for both the infant or child and other occupants in the vehicle.**
- If your child restraint requires a top tether strap, consult your authorized Volvo retailer for top tether anchorage and installation information.

When a child has outgrown the child safety seat, you should use the rear seat with the standard seat belt fastened. The best way to help protect the child here is to place the child on a cushion so that the seat belt is properly located on the hips (see [page 10](#)).

A specially designed and tested booster cushion (not available in Canada) for children between 50 - 80 lbs (22.7 - 36 kg) and 46 - 54" (117 - 137 cm) can be obtained from your Volvo retailer.

If necessary, an auxiliary seat for children is available for use in the luggage compartment of station wagon models. This seat is designed for two children, each weighing between 50 - 88 lbs. (23 - 40 kg) and up to 59 inches (150 cm) in height.

WARNING!

- When using the auxiliary seat for children, both sections of the rear seat backrest must be secured in the upright position.
- Do not use a booster cushion or child seat in conjunction with the auxiliary seat.

pg. 16 Occupant safety

Seat belt maintenance

Check periodically that the seat belts are in good condition. Use water and a mild detergent for cleaning. Check seat belt mechanism function as follows: Attach the seat belt and pull rapidly on the strap.

Volvo Concern for Safety

Safety is the cornerstone for Volvo. Our concern dates back to 1927 when the first Volvo rolled off the production line. Threepoint seat belts (a Volvo invention), safety cages, and energyabsorbing impact zones were designed into Volvo cars long before it was fashionable or required by government regulation. We will not compromise our commitment to safety. We continue to seek out new safety features and to refine those already in our cars. You can help. We would appreciate hearing your suggestions about improving automobile safety. We also want to know if you ever have a safety concern with your car. Call us in the U.S. at: 800-458-1552 or in Canada at: 800-663-8255.

Occupant safety

How safely you drive doesn't depend on how old you are but rather on:

- How well you see.
- Your ability to concentrate.
- How quickly you make decisions under stress to avoid an accident.

The tips listed below are suggestions to help you cope with the ever changing traffic environment.

- Never drink and drive.
- If you are taking any medication, consult your physician about its potential effects on your driving abilities.
- Take a driverretraining course
- Have your eyes checked regularly
- Keep your windshield and headlights clean.
- Replace wiper blades when they start to leave streaks.
- Take into account the traffic, road, and weather conditions, particularly with regard to stopping distance.

Reporting Safety Defects in the U.S.

If you believe that your vehicle has a defect which could cause a crash or could cause injury or death, you should immediately inform the National Highway Traffic Safety Administration (NHTSA) in addition to notifying Volvo Cars of North America. If NHTSA receives similar complaints, it may open an investigation, and if it finds that a safety defect exists in a group of vehicles, it may order a recall and remedy campaign. However, NHTSA cannot become involved in individual problems between you, your retailer, or Volvo Cars of North America. To contact NHTSA, you may either call the Auto Safety Hotline tollfree at 18004249393 (or 202-3660123 in Washington, D.C. area) or write to: NHTSA, U.S. Department of Transportation, Washington D.C. 20590. You can also obtain other information about motor vehicle safety from the Hotline.

Volvo strongly recommends that if your vehicle is covered under a service campaign, safety or emission recall or similar action, it should be completed as soon as possible. Please check with your local retailer or Volvo Cars of North America, Inc. if your vehicle is covered under these conditions.



[Contents](#) | [Top of Page](#)

2000 VOLVO S & V70

Chapter 2 - Instruments, switches and controls

pg. 18 Instruments, switches and controls

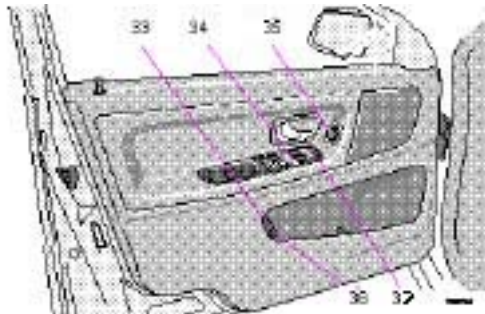
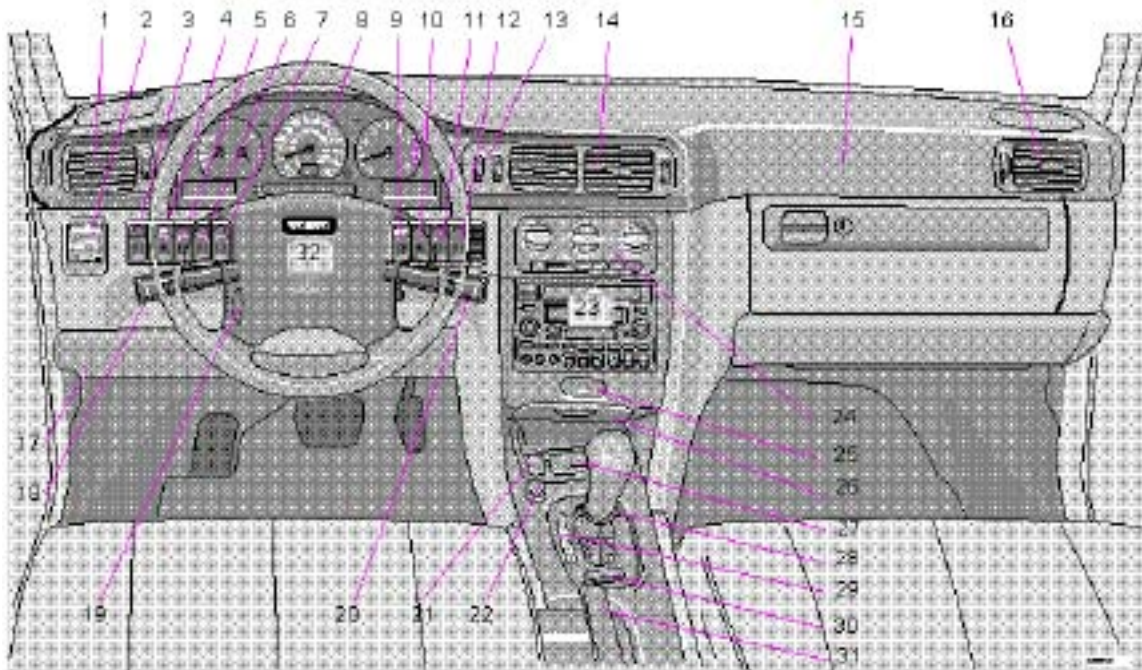

pg. 19 Instruments, switches and controls

The pages in this section provide detailed descriptions of the vehicle's instruments and controls. Note that vehicles may be equipped differently, depending on special legal requirements.

Page

1	Air vents	37
2	Headlights, parking lights	24
3	Instrument illumination	26
4	Rear fog light	26
5	Front fog lights (optional)	26
6	Space for additional equipment	
7	Space for additional equipment	
8	Instruments	19- 20
9	TRACS/STC (optional)	27
10	Trip computer (optional)	30- 32
11	Electrically operated sun roof (optional)	54
12	Rear window demister/heated door mirrors	27
13	Air mix	37
14	Air vents	37
15	Passenger side air bag (SRS) hatch	4-6
16	Air vents	37
17	Hood release	55
18	Turn signals, high/low beams/exterior courtesy lights	24
	Cruise control	33
19	Adjustable steering wheel	36
20	Windshield wiper/washer	25
	Tailgate wiper/washer (wagons)	28
21	Heated front seats (optional)	34
22	Auxiliary socket	35
23	Audio systems	141
24	Heating and ventilation controls	37- 41
25	Hazard warning flashers	27
26	Ashtray	35
27	Coin holder	

28	Shiftlock release button (automatic transmission only)	110
29	Gear selector shift positions	72-76
30	Winter mode selector	74,76
31	Parking brake	34
32	Horn/SRS	4-7
33	Trunk/tailgate open control	49
34	Power window controls	42
35	Power mirror controls	52
36	Fuel tank open control	69
37	Central locking button	45

Some of the items listed on this page are available on certain models only.

pg. 20 Instruments

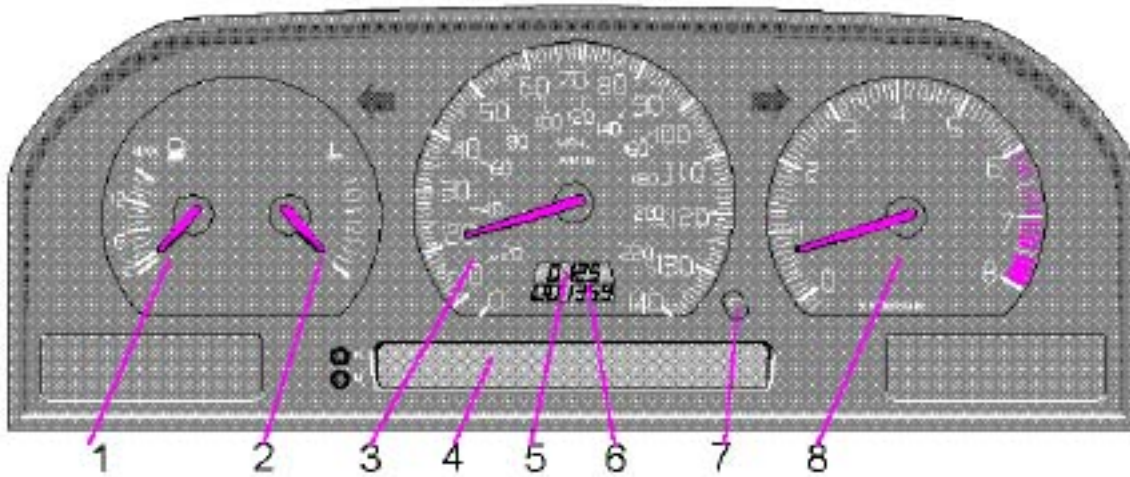

1 Fuel gauge

Fuel tank capacity:

18 US gal. (68 liters) - Front Wheel Drive

17.4 US gal (66 liters) - All Wheel Drive When the warning light comes on there is approximately 1.8 US gal. (8 liters) of fuel remaining. See "Refueling" for additional information.

2 Temperature gauge

Do not drive the car with the pointer in the red range. The pointer should be approximately midway on the gauge face when driving. If the pointer approaches the red range repeatedly, check coolant level.

3 Speedometer

4 Clock, ambient temperature sensor, trip computer (certain models)

5 Trip odometer

Used for measuring shorter distances. The last digit indicates 1/10 mile/kilometer.

6 Odometer

7 Trip odometer reset button

8 Tachometer

Reads thousands of engine rpm. Do not drive for long with the needle in the red section. The engine has an inbuilt function preventing too high a rotation speed. When this function operates, you may discern some pulsation, which in that case is quite normal.

NOTE: Digital displays showing Clock, Trip Odometer and Odometer will go off 30 minutes after the ignition has been switched off. To view these displays again, turn the ignition key to position I.

pg. 21 Indicator and warning lights

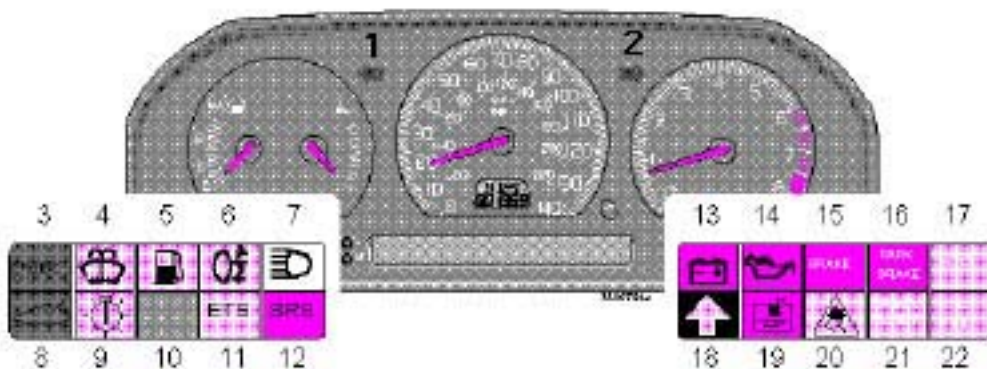

1 Turn signal, left

2 Turn signal, right

3 Cruise control

4 Low washer fluid level

If the lamp glows continuously when the engine is running, there is only about 1/2 - 1 US qt. remaining in the washer fluid reservoir.

5 Low fuel level

When the lamp glows, only about 1.8 US gals. (8 liters) of fuel remain. If the ignition is switched on while refuelling, the gauge may read inaccurately for up to 45 minutes.

6 Rear fog light

7 High beams

8 Trunk/tailgate open

9 Bulb failure warning sensor

10 (Not in use)

11 Electronic Throttle System (ETS)

12 SRS

13 Generator not charging

14 Low engine oil pressure

15 Brake warning light

16 Parking brake applied

17 ABS-system

18 Transmission mode: Indicates "W" if winter/wet driving mode is active, or indicates currently selected low gear.

19 Low coolant level

20 Traction Control (TRACS)/ Stability and Traction Control (STC) Systems (option)

21 Malfunction indicator lamp

(See [page 22](#) for more information)

22 Service reminder indicator

pg. 22 Warning lights

The warning lights described on pages 20 and 21 should never stay on when driving

When the ignition key is turned on and before the engine starts, all of the warning lights should go on to test the function of the bulbs. Should a light not go off after the engine has started, the system indicated should be inspected. However, the parking brake reminder light will not go off until the parking brake has been fully released.



Supplemental Restraint System (SRS)

If the light comes on (or stays on after the vehicle has started), the SRS diagnostic system has detected a fault. Drive to an authorized Volvo retailer for an inspection of the system. See the SRS section for more information.



Malfunction indicator lamp

If the lamp comes on (or stays on after the vehicle has started), the engine diagnostic system has detected a possible fault in the emission control system. Although driveability may not be affected, see an authorized Volvo retailer as soon as possible for inspection.

NOTE: If the fuel filler cap is not closed tightly or if the engine is running when the car is refueled, the Malfunction Indicator Lamp may indicate a fault. However, your vehicle's performance will not be affected. Use only Volvo original or approved fuel filler caps.



Oil pressure warning light

If the light comes on while driving, stop the car and then stop the engine immediately and check the engine oil level. See [page 124](#). If the light stays on after restart, have the car towed to the nearest authorized Volvo retailer. After hard driving, the light may come on occasionally when the engine is idling. This is normal, provided it goes off when the engine speed is increased.



Parking brake reminder light

This light will be on when the parking brake (hand brake) is applied. The parking brake lever is situated between the front seats.

Canadian models are equipped with this warning light: 



Cruise Control

This light will be on when cruise control is engaged. Cruise control will automatically disengage when the ignition is switched off.



Brake failure warning light

If the light comes on while driving or braking, stop immediately, open the hood and check the brake fluid level in the reservoir. See [page 131](#) for reservoir position.

Canadian models are equipped with this warning light: 

WARNING!

If the fluid level is below the MIN mark in either section of the reservoir: **DO NOT DRIVE.** Tow the car to a Volvo retailer and have the brake system checked and any leakage repaired.

ETS

Fault in ETC (Electronic Throttle Control system)

If this lamp comes on, there is a fault in the engine control system and driveability will be affected. Switch the ignition off and then on again. If the light remains on, the system should be inspected by an authorized Volvo retailer.

pg. 23 Warning lights



TRACS disengaged (option)

If the TRACS (TRAction Control System) is manually disengaged with the switch on the dashboard (see page 27), the warning light will come on. This will also come on to indicate a TRACS malfunction, and when the brakes overheat, although it goes out again at the normal temperature level. **If the lamp remains on, the system should be checked by an authorized Volvo retailer.** This lamp should not be confused with the ON/OFF indicator lamp above the switch.



STC disengaged (option)

The indicator light () in the instrument panel will be ON when you have switched the Stability and Traction Control system (STC) OFF using the button on the dashboard (see page 25). The light will also come on if there is a fault in the STC system or to indicate that the brakes have overheated. The light will go out when the brake temperature returns to normal.

The symbol will flash when STC is actively regulating power to the drive wheels. Normal power may be reduced at this time. This is normal as power is momentarily reduced to help keep the drive wheels from losing traction and spinning.



Coolant level sensor

If this light comes on while driving, the coolant level is low. The coolant level in the expansion tank should be checked immediately and topped up if necessary. The cooling system should be inspected by

an authorized Volvo retailer.



Mode "W" engaged

The lamp will light up when the Winter/Wet starting mode is engaged or if gears "4-1" or "L" are selected.

If the warning lamp begins to **flash**, this means that there is a fault in the automatic gearbox. Contact Your Volvo retailer.



Generator warning light

If the light comes on while the engine is running, have the charging system checked.



Service reminder indicator

This light will come on at 7,500 mile (12,000 km) intervals, after 750 hours of driving or after 12 months, whichever occurs first. It is a reminder to the driver that the service interval has been exceeded. The light will stay on for 2 minutes after start until reset by the servicing retailer.



Bulb failure warning light

The light will come on if any of the following bulbs are defective:

- one of the low beam headlights
- one of the tail lights
- one of the brake lights when the brake pedal is depressed.

Check the fuse and bulb. See sections "Replacing bulbs" and "fuses."

Should the warning light come on after a defective outside bulb has been replaced, the corresponding bulb on the other side of the car should also be replaced.



Anti-lock Brake system (ABS)

If the warning lamp lights up there is a malfunction of the ABS system (the standard braking system will however function). The vehicle should be driven to a Volvo retailer for inspection.

See [page 83](#) for additional information.

Canadian models are equipped with this warning light:



pg. 24 Headlights, Parking lights, Exterior courtesy lights, Turn signals

Headlights and parking lights

All lights off *

Parking lights on *

Headlights and parking lights are on if starting (ignition) switch is in positions I or II.

If the headlight switch is in the position all lights will go out when the starting switch is switched off.

With the headlight switch in position the parking lights will stay on (headlights off) with the daytime running light screw (A) in position .

The high beams can only be switched on if the headlight switch is in position .

Switch from high to low beams and vice versa by moving the turn signal switch lever on the left side of steering column towards the steering wheel.

* See [page 26](#) for information on Daytime running lights.

Exterior courtesy lights

When you leave your car at night, you can make use of the exterior courtesy lighting function:

- Remove the key from the ignition switch.
- Pull the direction indicator lever towards the steering wheel (as when using the headlight flasher

function).

The low beam headlights will now remain on for 30 seconds to light your way.

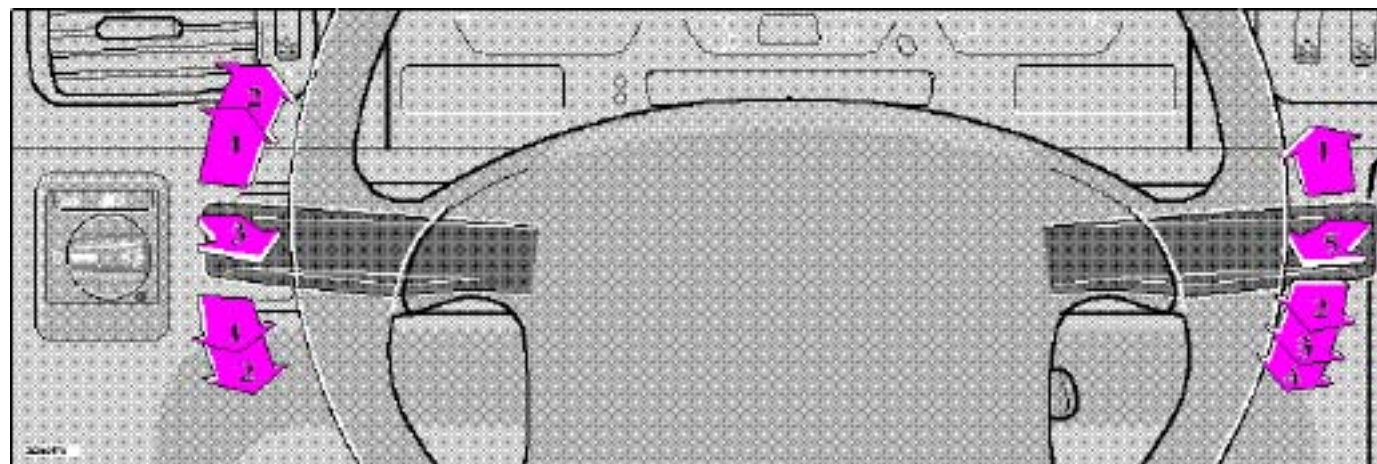

Turn signals

1 Lane change position. In maneuvers such as lane changing, the driver can flash the turn signals by moving the turn signal lever to the first stop and holding it there. The lever will return to the neutral position when released.

2 Signal lever engaged for normal turns.

3 High beam/low beam switch (headlights on).

Move the lever towards the steering wheel and release it.

Headlight flasher (headlights off).

Move the lever towards the steering wheel. The headlight high beam will be on until the lever is released.

NOTE: A defective turn signal bulb will cause the turn signal indicator and remaining signal lights to flash more rapidly than normal.

pg. 25 Windshield wipers/washers, Ignition switch/steering wheel lock

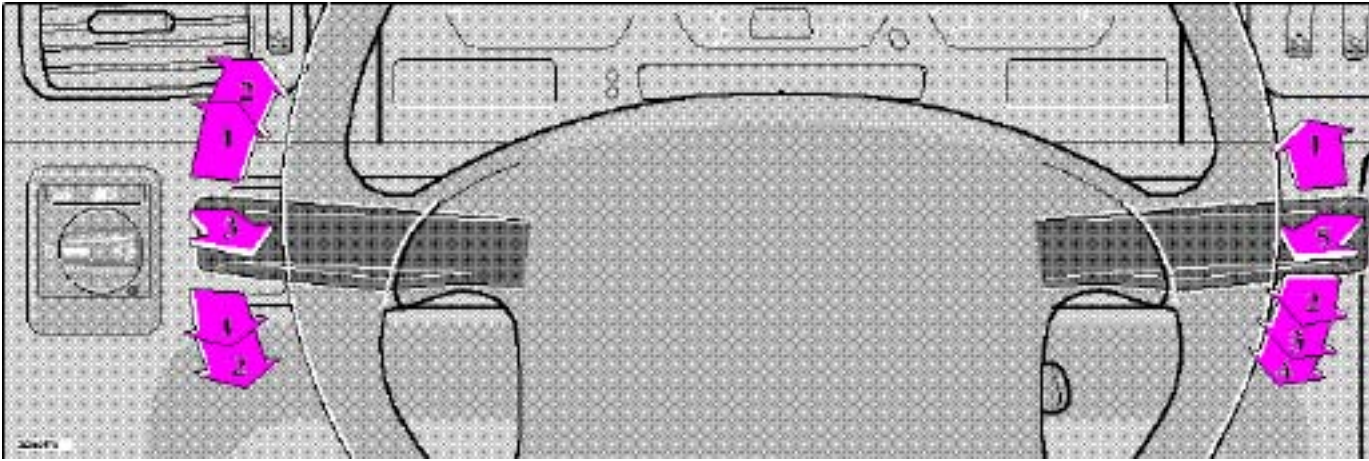

Windshield wipers/washers

1 Intermittent wiper

With the switch in this position, the wipers will sweep approximately every seventh second.

2 "Single sweep" position:

The switch returns automatically when released.

3 Wipers, normal speed

4 Wipers, high speed

5 Windshield wiper/washer, headlight wiper/washer (certain models)

The wipers will make 23 sweeps across the windshield and headlights (certain models) after the lever is released.

O Locked position:

Remove the key to lock the steering wheel*

 **WARNING!** Never turn the key to position O while driving or when the car is being towed.

I Intermediate position:

Certain accessories, radio, etc. on, daytime running lights off.

II Drive position:

Key position when engine is running.

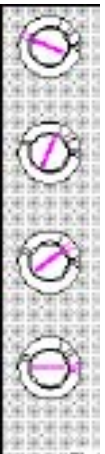

III Starting position:

Release the key when the engine starts. The key returns automatically to the Drive position.

* On cars equipped with an automatic transmission the gear selector must also be in the (P)ark position.

Starting (ignition) switch/steering wheel lock

If you find it difficult to insert the key in the ignition or to move the steering wheel, the steering wheel lock might be under tension. Turn the wheel back and forth slightly to free the ignition key.

In order to reduce car theft, make sure the steering wheel locks before leaving the car.

A chime will sound if the starting key is left in the ignition lock and the front door on the driver's side is opened.

pg. 26 Instrument illumination, Fog lights

1 - Instrument illumination

To increase the brightness: move the thumbwheel up.

To decrease the brightness: move the thumbwheel down.

2 - Rear fog light *

The rear fog light (located in the driver's side tail light cluster) is considerably brighter than the normal tail lights and should be used only when the atmospheric conditions, such as fog, rain, snow, smoke or dust reduce the daytime or nighttime visibility of other vehicles to less than 500 ft (150 meters).

For the rear fog light to function, the low beam headlights must be switched on.

* By design, there is one rear fog light only, located in the driver's side tail light cluster.

3 - Front fog lights (option)

The front fog lights, located in the front spoiler, will only function in combination with the low beam headlights.

4 - Space for optional equipment

5 - Space for optional equipment

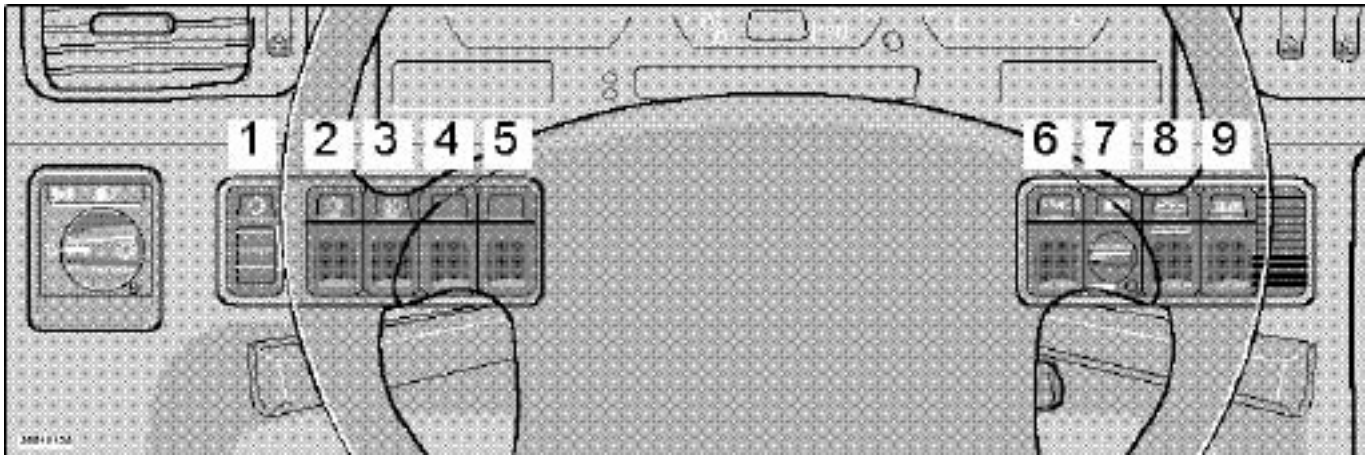

[Contents](#) | [Top of Page](#)

2000 VOLVO S & V70

pg. 27 TRACS, Sun roof, Trip computer, Hazard warning flashers, Demister

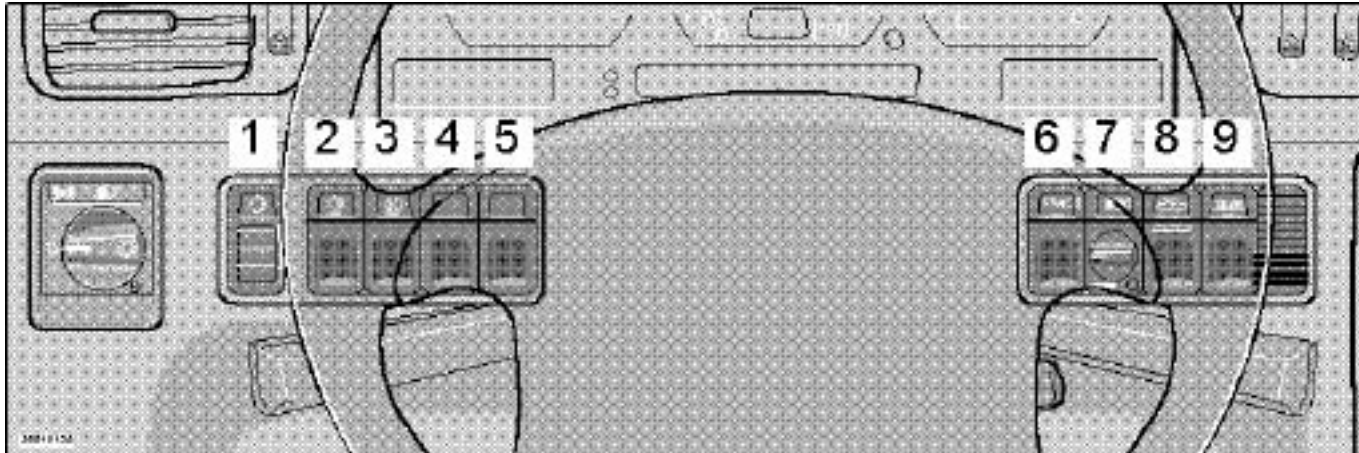

6 - TRAction Control System (TRACS)/Stability and Traction control (STC) - option

See [page 84](#) for more information on these systems.

7 - Trip computer - option

Turn the dial to the desired function. For more information, see pages 30-32.

8 - Electrically operated sun roof - option

See [page 54](#) for operating instructions.

9 - Rear window demister, heated side-view mirrors

Press the switch to start heating the rear window and side-view mirrors. The control light in the switch will illuminate.

A timer switches off the system after approximately 12 minutes. The control light will go out

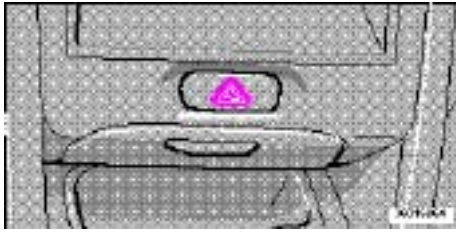

correspondingly.

Hazard warning flashers

The four-way flasher (located above the ashtray) should be used to indicate that the vehicle has become a traffic hazard.

NOTE: Regulations regarding the use of the hazard warning flasher may vary from state to state.

pg. 28 Daytime running lights, Tailgate wiper/washer (wagons)

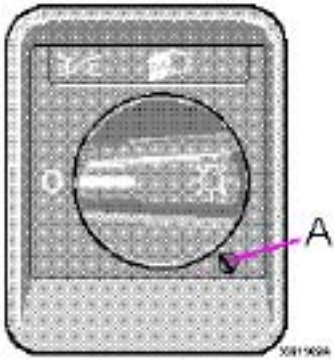

Automatic daytime running lights

Screw **A** in the illustration (available on U.S. models only) is used to control the automatic daytime running lights when the headlight switch is in position 0.

The low beams, tail lights, parking lights and license plate lights will come on automatically when the ignition is switched on.

To adjust, press in the screw with a small screwdriver and turn to one of the following positions:

■ **Automatic daytime running lights**

■ **Automatic daytime running lights**

The daytime running lights will also function when the headlight switch is in position and switch A is in this position.

■ **All lights off** (daytime running light function disabled)

NOTE: The daytime running light function may only be disabled (turned off) in the U.S. Canadian law mandates the use of daytime running lights.

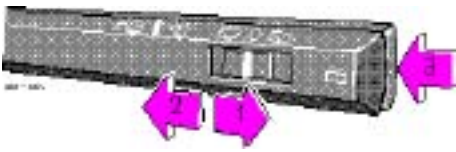

Tailgate wiper/washer (wagons)

Tailgate window wiper/washer The tailgate window wiper/washer is operated by a switch at the end of the wiper lever.

1. The wiper operates continuously.
2. Intermittent position: the wiper strokes approximately every 10 seconds.
3. Tailgate washer (note that the wiper also operates when this button is depressed):

after the button is released the wiper strokes 23 additional times before stopping.

pg. 29 Clock, Ambient temperature sensor (certain models)



Resetting the clock

The digital clock can be reset by pressing one of the two buttons (A and B) with a pointed object such as the tip of a pen.

h = hours

m = minutes

Maintain the pressure on the buttons for more than four seconds to change the time more quickly.

NOTE: Digital displays showing the Clock will go off 30 minutes after the ignition has been switched off. To view this display again, turn the ignition key to position I.

Ambient temperature sensor

This sensor indicates the temperature slightly above the road surface and represents air temperature where road icing may occur. An amber indicator light (C) in the "snowflake" symbol lights up when the temperature is in the range of 23 - 36° F (-5 - +2° C). **Please note that this light does not indicate a fault with your car.**

At low speeds or when the car is not moving, the temperature readings may be slightly higher than the actual ambient temperature due to the heat generated by the engine.

Display alternatives

If buttons A and B are pressed down simultaneously, it is possible to shift between four different display alternatives:

Press 1st time: 12 hour clock and °F

Press 2nd time: 24 hour clock and °F

Press 3rd time: 12 hour clock and °C

Press 4th time: 24 hour clock and °C

pg. 30 Trip computer (certain models)

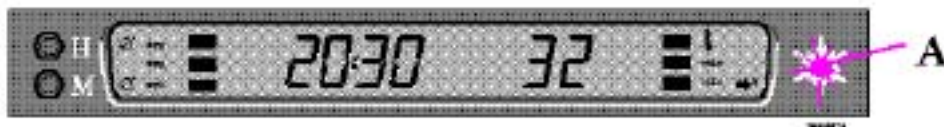

Trip computer

The trip computer offers six functions which are presented in a single display. The cursor indicates the selected function. The trip computer's clock is shown permanently in the left-hand field. Refer to the previous page for more detailed information regarding the clock function.

The following data is monitored by the computer:

- Average speed

- Current fuel consumption
- Average fuel consumption
- Ambient temperature *
- Tripmeter
- Driving distance on current fuel reserve

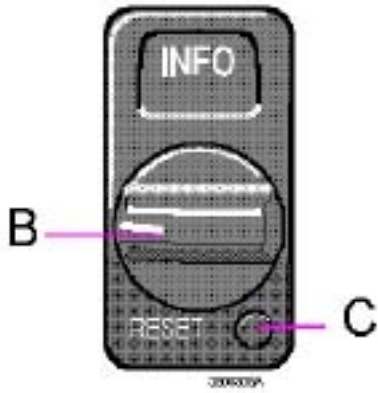

Trip computer controls

Select one of the trip computer's six functions by using control B. The Reset button (C) is used to reset the following functions:

- Average speed
- Average fuel consumption
- Trip meter

Rotate the control to the required position and press the button for at least two seconds to reset the selected function.

NOTE: If pressure is maintained on the button for another three seconds, all three of the functions mentioned above will be reset.

* Warning light A in the illustration above. See [page 32](#) for more details.

pg. 31 Trip computer (certain models)

Average speed Ø mph (Canada: km/h)

Average speed since the function was last reset. When the ignition is switched off, the average speed is stored in memory and is used as the basis for the new figure when the engine is started again. It can be reset by pressing the reset button on the trip computer control.



Current fuel consumption mpg (Canada: L/100 km)

Continuous information on current fuel consumption, calculated once per second. When the car is not moving, the display shows "---".

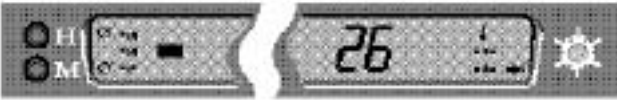

Average fuel consumption Ø mpg (Canada: L/100 km)

Average fuel consumption since the function was last reset. When the ignition is switched off, the average fuel consumption figure is stored in memory and remains in memory until it is reset using the button on the trip computer control.

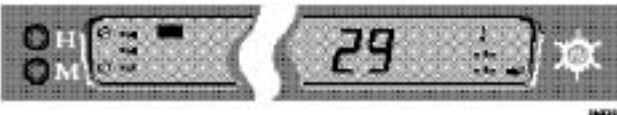

pg. 32 Trip computer (certain models)

Ambient temperature

Shows the ambient temperature just above the road surface while driving. When the temperature is in the range 2336° F (5 - +2° C), the ambient temperature sensor activates an indicator light in the "snowflake" symbol to help alert the driver of possible slippery driving conditions. **Please note that this light does not indicate a fault with your car.**

At low speeds or when the car is not moving, the temperature readings may be slightly higher than the actual ambient temperature due to the heat generated by the engine.

Tripmeter in miles (Canada: km)

Shows the distance driven since the function was last reset. This value is stored in memory until it is reset using the reset button on the trip computer control.



Driving distance on current fuel reserve mile 0 (Canada: km)

Shows the approximate distance which can be driven on the fuel remaining in the tank, calculated on the basis of the average fuel consumption during the last 12 miles (20 km) driven and the amount of fuel remaining in the tank at the time of the reading.



When the quantity of fuel drops to below approximately 1.8 US gals. (8 liters), a warning light in the instrument panel comes on. When the driving distance on the current fuel reserve is less than 12 miles (20 km), the display shows "—".



pg. 33 Cruise control



Cruise control

The cruise control switches are located on the turn signal lever. The indicator light on the instrument panel (see page 19) will come on when cruise control is engaged.

To engage and set the desired speed:

1. Set switch (B) to ON.
2. Accelerate to the desired cruise speed.
3. Press the + or - area of the SET button (A) to set the desired speed.

NOTE: The cruise control cannot be engaged at speeds below 22 mph (35 km).

Braking

This will automatically disengage the cruise control. The previously selected cruise speed is retained in the memory and by momentarily setting the switch to the RESUME position, that speed will be reengaged.

If the cruise control is already engaged, the cruising speed can be increased or decreased by depressing the SET button (A) towards either + or -. One short press on the button corresponds to a speed change of approx. 1 mph (1.6 km/h). When the button is released, the vehicle will maintain the current speed.

If the actual speed falls below 70% of the set speed or if the wheels spin or lock, the cruise control will disengage automatically.

NOTE: (AUTOMATIC TRANSMISSION) When driving up steep hills with the cruise control engaged, the transmission may shift intermittently.

Acceleration

Momentary acceleration, such as for passing, does not interrupt cruise control operation. The previously selected speed will be maintained without having to set the switch to RESUME.

To disengage the cruise control system:

Set switch (B) to OFF, depress the brake pedal or move the gear selector to position N.

Switching off the starting (ignition) switch will automatically disengage the cruise control system.

On cars equipped with manual transmissions, the cruise control can also be disengaged by depressing the clutch.

WARNING!

The cruise control should not be used in heavy traffic or when driving on wet or slippery roads. Do not use or resume cruise control in reverse gear.

NOTE: When the ignition is switched off, any information stored in the cruise control memory is erased.



[Contents](#) | [Top of Page](#)

2000 VOLVO S & V70

pg. 34 Heated front seats (certain models), Parking brake

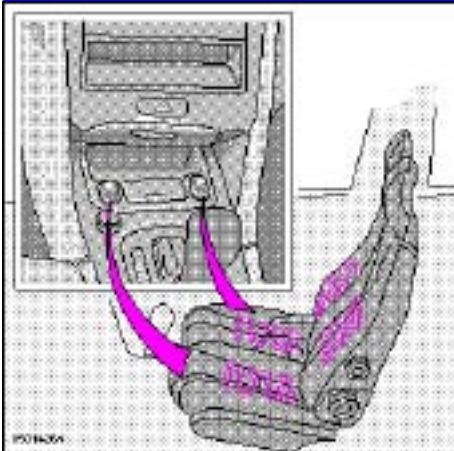

Heated front seats

The heated front seats can be switched on and off as required. When switched on, the system senses the ambient temperature and regulates the level of heat applied. When the optimum temperature is reached, the heating switches off automatically. While driving, the seat heating for the passenger seat should be switched off when the seat is not occupied.

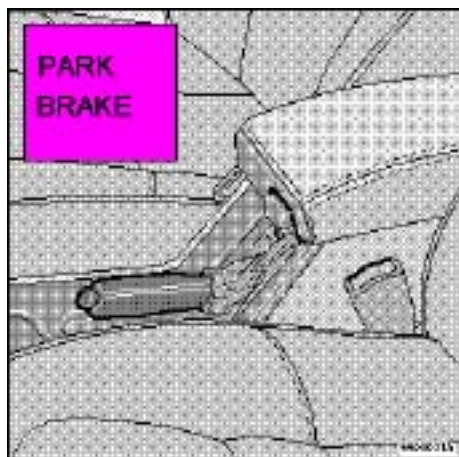

Parking brake lever

Parking brake (hand brake)

The lever is situated between the front seats. The brake is applied to the rear wheels.

WARNING!

Always use the parking brake (hand brake) when parking. On hills, also turn the front wheels toward the curb.

The indicator light in the instrument panel will light up even if the parking brake is only applied slightly. Be sure to pull the lever up sufficiently.

pg. 35 Ashtrays, Auxiliary socket

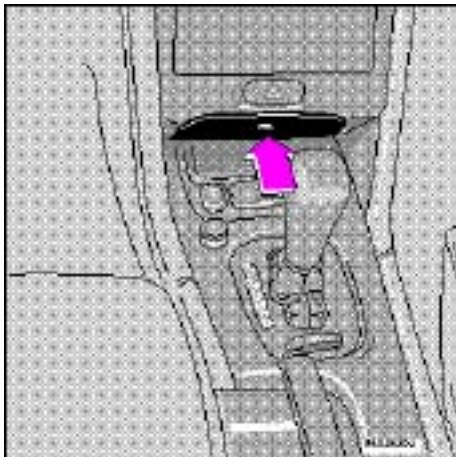

Ashtray

Front ashtray

To **open** the front ashtray, press lightly on the panel.

To **empty** the front ashtray:

- Put the gear selector (aut. transmission) in position L.
- Grasp the front edge of the ashtray and pull it straight out.

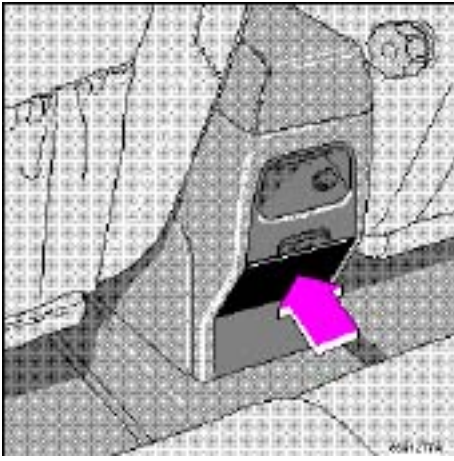

Rear seat auxiliary socket and ashtray*

Rear ashtray

To **open** the rear ashtray, pull it straight out.

To **empty** the rear ashtray, pull it out, lift up the rear edge and remove.

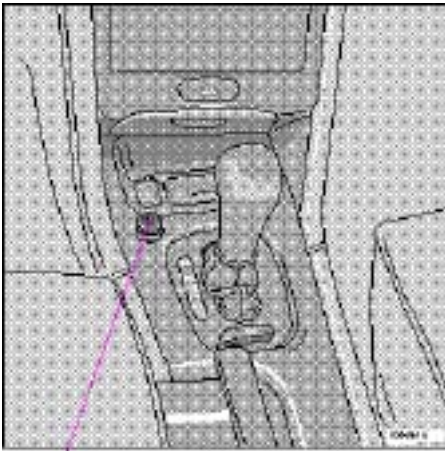

*Front auxiliary socket**

Auxiliary socket

This 12 volt socket can be used to plug in certain accessories such as cellular telephones, etc. The key must be in position I (or higher) for the auxiliary socket to function.

NOTE: The "OBD II" terminal, a connector for diagnostic equipment, is located under the cover of the storage compartment between the front seats. This terminal is intended for use by authorized service technicians only.

* The auxiliary sockets can also be used as cigarette lighters, which are available at your Volvo retailer.

pg. 36 Steering wheel adjustment

Steering wheel adjustment

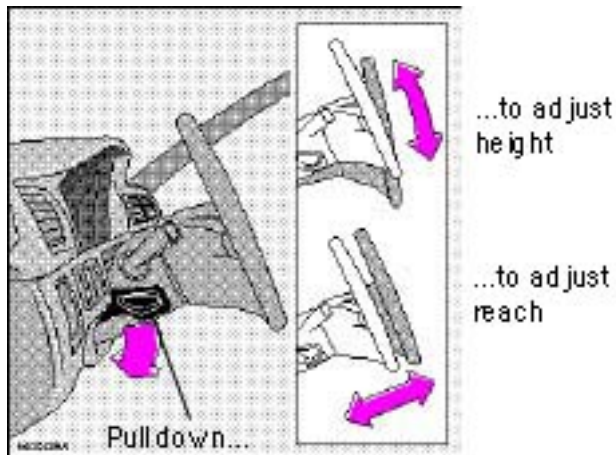

Steering wheel adjustment

Both the height and the reach of the steering wheel can be adjusted to a comfortable position for the driver. Pull down the lever on the left of the steering column. Adjust the steering wheel to a suitable position and press the lever back into place to lock the steering wheel in the new position. Check that the steering wheel is locked in the new position.

WARNING!

Never adjust the steering wheel while driving.

pg. 37 Heating, ventilation and air conditioning

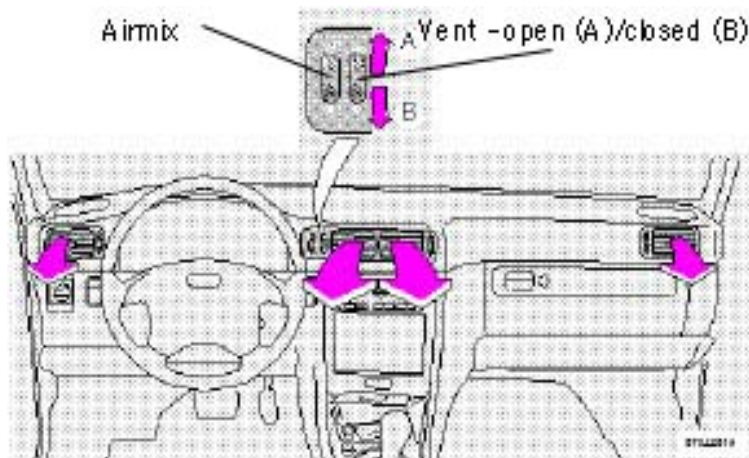

BHeating and air conditioning

Your Volvo is equipped with a heating system combined with air conditioning. Depending on which function you select, warm or cool/cold air is distributed to the different parts of the passenger compartment. A slight amount of condensation may be emitted from the air vents when the air conditioning is initially switched on. This can occur when both humidity and ambient temperature are high and is normal.

Air mix (fresh air)

The center panel vents have an air mix function which allows fresh air to enter the passenger compartment when the vents are open (position A). This function is designed to allow you to direct cool air toward your face while directing warmer air to the rest of the passenger compartment.

To warm/cool the compartment as quickly as possible, the air mix control should be in the closed

position.

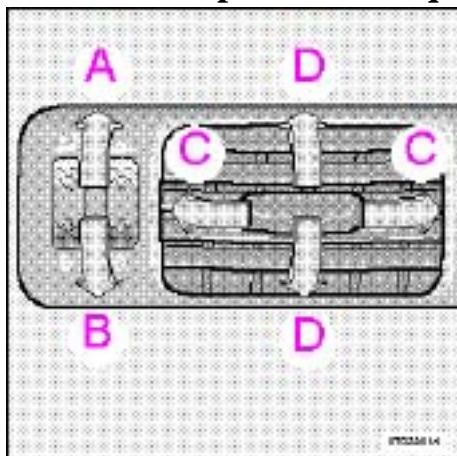

Air vents (dash)

- A Open
- B Closed
- C Directing air flow horizontally
- D Directing air flow vertically

Refrigerant

Volvo cares about the environment. The air conditioning system in your car contains a CFC-free refrigerant - R134a. This substance will not deplete the ozone layer. The system contains 1.63 lbs (0.75 kg) R134a and uses ZXL 100PG (type PAG) oil.

NOTE: All maintenance on the climate control systems should be carried out by an authorized Volvo service technician only.

pg. 38 Heating, ventilation and air conditioning (standard unit)

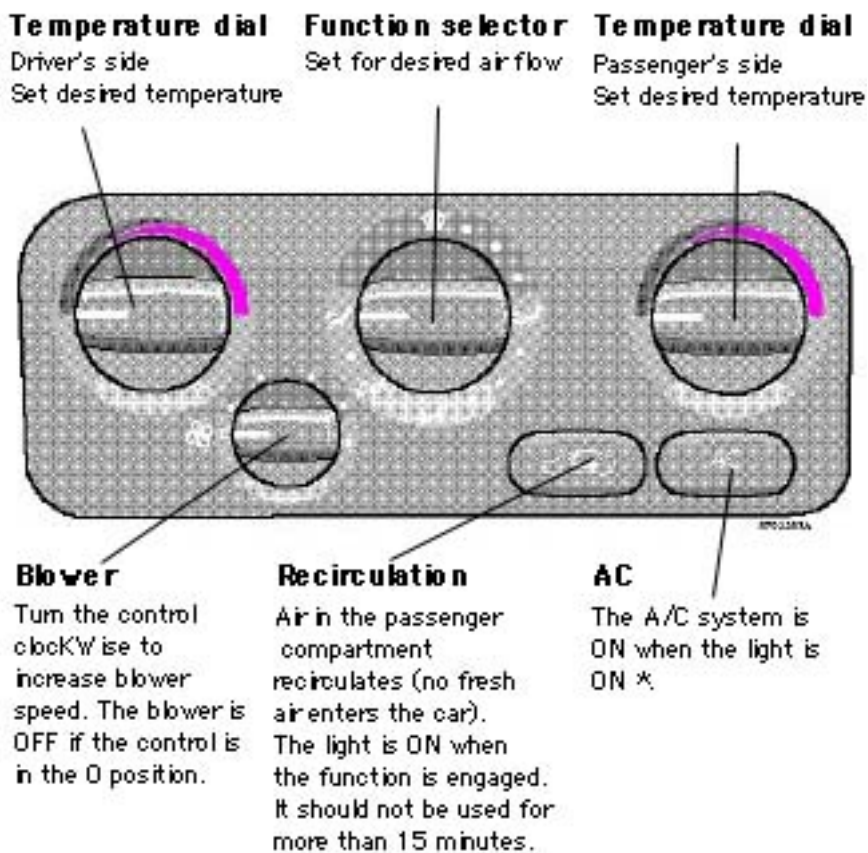

* When the function selector is in the defrost setting, the A/C will automatically be ON if recirculation is **not** on and the blower control is not in position 0.

Function selector

Air through panel vents

Defrost. Air to windshield and side windows.

Air to floor, windshield and side windows.

Air through floor vents.

Bi-level. Air through floor and panel vents.

NOTE: If your windows begin to fog or mist, check that the recirculation function is **NOT** engaged.

Faults in the A/C system

The RECIRCULATION and AC lights will flash for approximately 20 seconds if a fault is detected in the A/C system.

If this flashing recurs the next time the system is switched on, the climate control unit should be checked by an authorized Volvo retailer.

pg. 39 Heating, ventilation and air conditioning (standard unit)

Maximum heating:

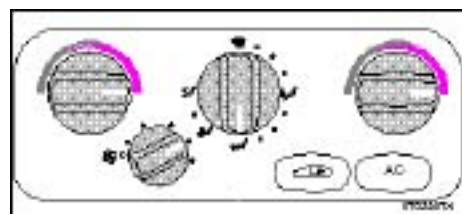

Close the center panel vents. When the passenger compartment has become sufficiently warm, set the blower control to the fourth position, adjust the temperature and open the side air vents.

Maximum cooling:

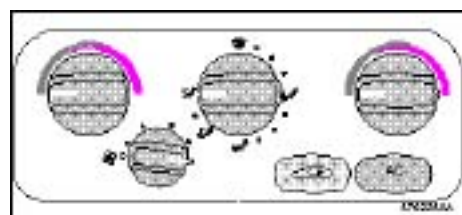

Open the vents. The A/C and recirculation should be ON.

Adjust the temperature with the temperature selectors to raise the temperature if necessary.

The recirculation function should not be used for more than 15 minutes.

To demist/defrost the windows:

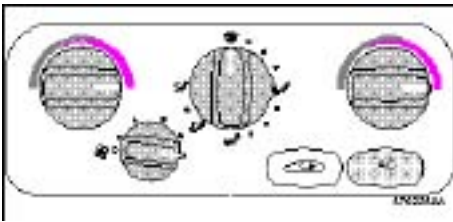

Set the function selector to and the blower control to the highest position. The A/C will be ON if recirculation is not on. When the windows have cleared, set the blower control to the second position and the function selector to the desired position. Always keep the air intake grille at the base of the windshield under the rear edge of the hood free of snow.

Additional information

- The air conditioning system will function best if it is always left on.
- Water under the vehicle in hot weather can be the result of condensation from the air conditioning system and is quite normal.
- The air conditioning system functions only at temperatures above 32° F (0° C).
- Use the **RECIRCULATION** function if the outside air is contaminated with exhaust gases, smoke, etc or to heat/cool the car quickly. In this position, very little air is drawn into the passenger compartment from the outside. Do not leave the system in this mode for more than 10-15 minutes since the air inside the car will become stale. The temperature can be controlled with the temperature selectors.
- If the panel vents are open, a certain amount of air will always flow through, regardless of the position the function selector is in. To increase the flow of air to either the floor or the windows, close the panel vents and open the outer vents.
- The panel vents may emit some condensation when the air conditioning is initially switched on and is quite normal. This may occur if the ambient temperature and humidity are high.
- The air conditioning is momentarily disengaged during full-throttle acceleration.

pg. 40 Heating, ventilation and air conditioning (Electronic Climate Control) - option

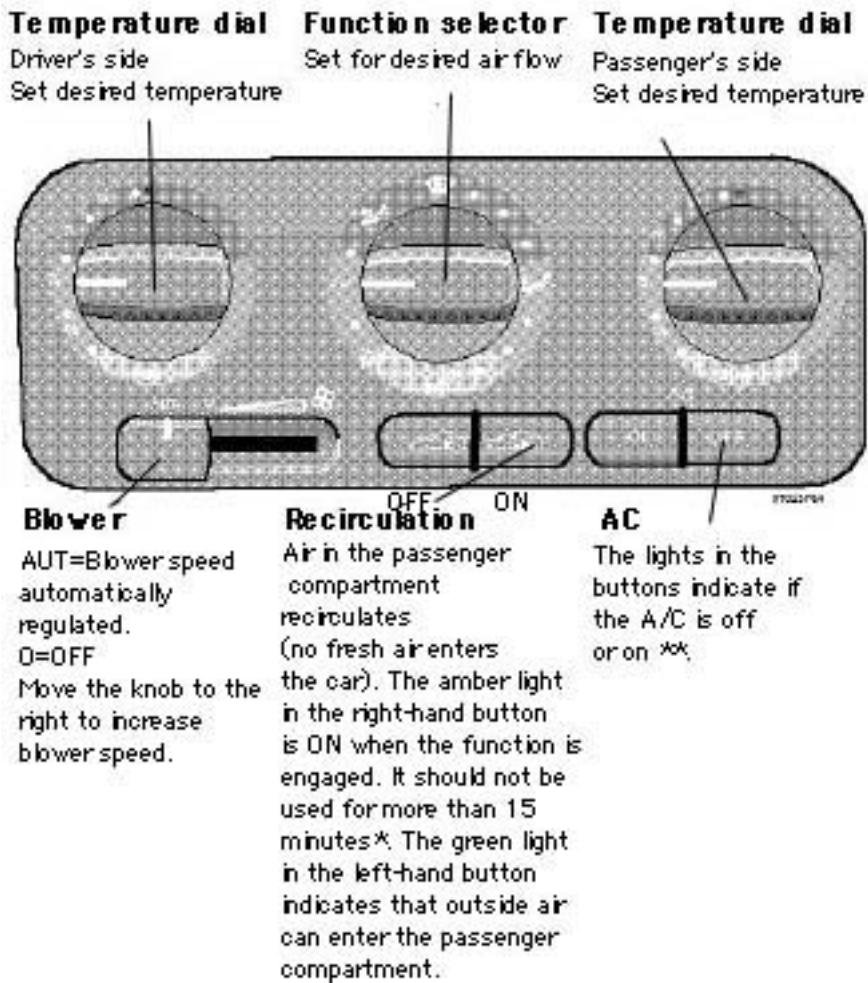

Function selector

AUT Air distribution automatically regulated

- Air through panel vents
- Defrost. Air to windshield and side windows. Recirculation will not function regardless of button setting.
- Air to floor, windshield and side windows.
- Air through floor vents.
- Bi-level. Air through floor and panel vents.

* Pressing the ON section of the button for more than 3 seconds activates a **timer function**. Recirculation will then always operate for 5 minute periods, after which the button will flash to indicate that Recirculation has automatically switched off. Pressing the OFF button at any time during the 5

minute period will allow fresh air into the passenger compartment. Press the ON button again for more than 3 seconds to return the button to its original function (i.e., Recirculation will remain on until the OFF button is pressed).

** When the function selector is in the defrost setting, the A/C system is always ON and the blower will function at its highest speed if it is in the AUT position.

pg. 41 Heating, ventilation and air conditioning (Electronic Climate Control) - option

Automatic setting

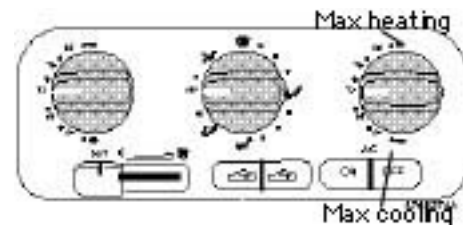

Set the mode selector and blower control to AUT and select the desired temperature. If the driver's side temperature selector is set to either the max heating or max cooling position, the blower will run at its maximum speed.

Optimum defrosting

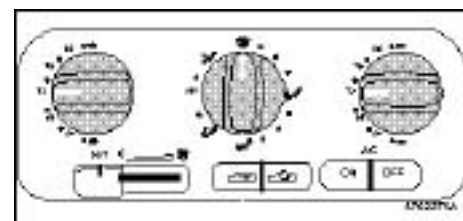

Set the function selector to and move the blower control to the position AUT (as far to the left as possible). The A/C system will be on at this time even if the AC OFF button is depressed and the blower will run at its maximum speed. When the windows have cleared, set the function selector in the AUT position.

Additional information

- The air conditioning system will function best if it is always left on.
- Always keep the air intake grille at the base of the windshield under the rear edge of the hood free of snow.
- Water under the vehicle in hot weather can be the result of condensation from the air conditioning system and is quite normal.
- The air conditioning is disengaged when the blower is set at 0 and the speed of the vehicle is less than 20 mph (30 km/h).
- The air conditioning system functions only at temperatures above 32° F (0° C).

- **RECIRCULATION:** Use this function if the outside air is contaminated with exhaust gases, smoke, etc or to heat/cool the car quickly. When Recirculation is activated, very little air is drawn into the passenger compartment from the outside. *If your windows begin to fog or mist, check that the recirculation function is NOT engaged.*

NOTE: When driving with the sun roof or windows open, to help maintain stable passenger compartment temperature, use the blower control to manually regulate the blower speed.

- If the panel vents are open, a certain amount of air will always flow through, regardless of the position the function dial is in. To increase the flow of air to either the floor or the windows, close the panel vents and open the outer vents.
- The panel vents may emit some condensation when the air conditioning is initially switched on and is quite normal.

This may occur if the ambient temperature and humidity are high.

- The sunlight sensor (located at the top center of the dashboard) should not be covered in any way as this could cause incorrect information to be sent to the ECC system.
- The air conditioning is momentarily disengaged during full-throttle acceleration.

Difficult weather conditions

When driving in very humid conditions, heavy rain, sleet, etc., it may be better to use the manual rather than the automatic setting to defrost the windows. Set the mode selector to "Defrost"  or "Defrost/floor" and the fan speed to mid-range. Also shut the center air vents.

Faults in the ECC system

The RECIRCULATION ON and AC OFF lights will flash for approximately 20 seconds if a fault is detected in the ECC system.

If this flashing recurs the next time the system is switched on, the climate control unit should be checked by an authorized Volvo retailer.

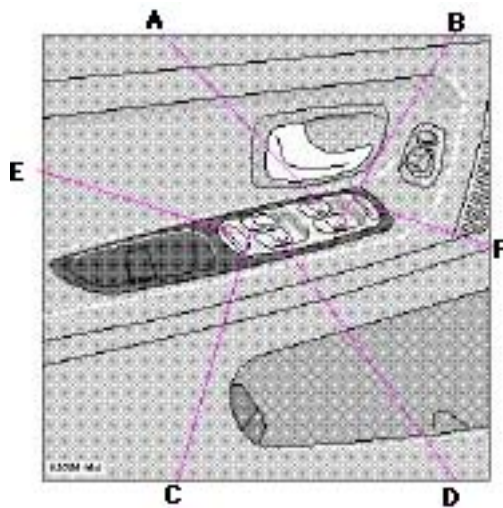

- A- left front
- B- right front
- C- left rear
- D- right rear
- E- Cutout switch, rear windows
- F- central locking button (see [page 43](#))

Electrically operated windows

The electrically operated windows are controlled by switches in the driver's door as shown in the illustration above. The starting (ignition) switch must be ON (intermediate position I) for the electrically operated windows to function.

To lower: press down on the front edge of the button

To raise: pull up on the front edge of the button.

NOTE:

- **Auto-down function** (driver's window only): The window can be opened completely by pressing the front part of the switch lightly and **releasing** it immediately. The window can be stopped by pressing the button again. If the button is held down, the window will be lowered until the button is released.
- The power window motors have an overload protecting circuit breaker which is activated when an object blocks a window. Should this occur, remove the object and wait 20 seconds for the circuit breaker to reset. The power windows should then function.

Cutout switch for rear windows

If your car is equipped with electrically operated rear door windows, this function can be disabled by a switch located on the driver's door (see illustration).

ON The rear door windows can be raised or lowered with the respective door switches as well as with the switches on the driver's door armrest.

OFF The rear door windows **cannot** be raised or lowered with the respective door switches but instead **only** with the corresponding switches on the driver's door armrest.

WARNING!

- Remove the ignition key when children are left unattended in the vehicle.
- Make sure that children's hands are clear before raising the windows.
- Never leave children unattended in the car.



[Contents](#) | [Top of Page](#)

2000 VOLVO S & V70

Chapter 3 - Body and interior

pg. 43 Body and interior

The seats, sun roof, mirrors, etc. are described on the following pages.

Keys	44
Doors and locks	45
Remote keyless entry system	46
Alarm	47
Trunk/tailgate	49
Child safety locks	50
Front seats	51- 52
Rear/side view mirrors	52
Interior lights, Vanity mirror	53
Sun roof	54
Hood	55
Storage compartments	56
Trunk light, Spare tire, Jack	57
Cargo space lighting, Spare tire, Jack (wagon)	58
Folding rear seat (sedan)	59
Folding rear seat (wagon)	60- 61
Removing seat cushions	61
Concealed storage bin/Bumper cover (wagon), Avoiding battery drain	62

Luggage net/Side cargo net (wagon) [63](#)

Securing cargo [64](#)

Folding front seat, Long load storage [65](#)

pg. 44 Keys

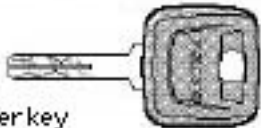
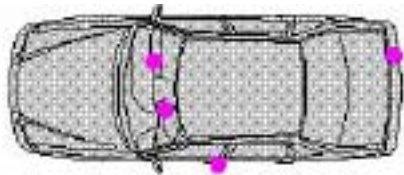

Master key

This key operates all locks (ignition switch/steering wheel lock, driver's door, trunk and glove compartment).

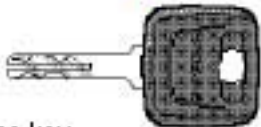
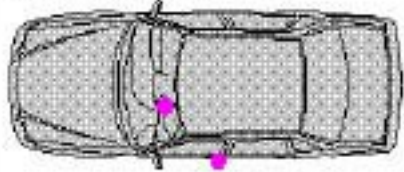

Service key

This key operates the driver's door and the ignition switch/steering wheel lock.

NOTE:

- As an added anti-theft measure, new keys have been developed which may take slightly longer to copy or replace if the original keys are misplaced. Duplicate keys may be ordered from your Volvo retailer.
- The key number codes are stamped on a separate tag supplied with the keys. This tag should be separated from the key ring and kept in a safe place.

Immobilizer (start inhibitor)

Each of the keys supplied with your car contains a coded transmitter and receiver (transponder). The code in the key is transmitted to an antenna in the ignition switch where it is compared to the code stored in the start inhibitor module. The car can only be started if a properly coded key is used.

If you misplace a key, take the other keys to an authorized Volvo retailer. The existing code in the start inhibitor module and all the keys will be erased as an antitheft measure and a new code will be

programmed in.

NOTE:

Not more than one of the keys for your car should be kept on the same key ring. This could cause conflicting signals to be transmitted to the ignition switch, making it impossible to start the car.

This device complies with part 15 of the FCC rules. Operation is subject to the following condition: (1) This device may not cause harmful interference, and (2) this device must accept any interference received, including interference that may cause undesired operation.

pg. 45 Doors and locks

Doors and locks

Your car is equipped with a central locking system.

The key, used on the driver's door, the remote control, or central locking button, will lock/unlock all doors, trunk/tailgate.

Turn the key once to unlock the driver's door only.

Turn the key again (within 10 seconds) to unlock all doors, trunk/tailgate.

One turn with the key towards lock in the drivers door locks all doors, trunk/tailgate.

Use the switch on the front door armrests to lock/unlock the car from the inside.

Check the action of the buttons on the other doors to verify their correct function (lock/ unlock).

WARNING!

If the doors are locked while driving, this may hinder rapid access to the occupants of the car in the event of an accident. (Also see information on "Child safety locks").

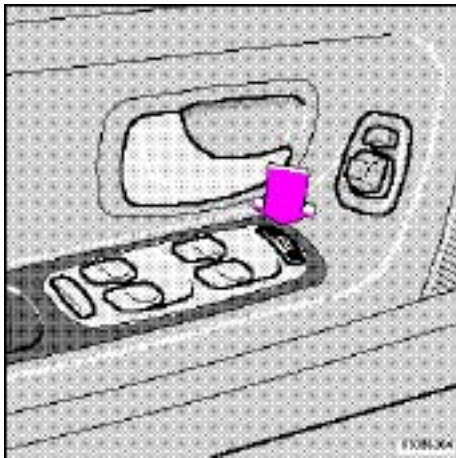

Central locking button (on both front doors)

Central locking button

The central locking buttons on both front door armrests can be used to lock or unlock all doors and trunk/tailgate and set the alarm if your car is so equipped. This switch functions even if a door/trunk/tailgate is open.

Lock: Press the left side of the button.

Unlock: Press the right side of the button.

Note: To help prevent accidentally locking the keys in the car, the central locking system is designed to unlock the driver's door immediately if the key is left in the ignition switch and the car is locked using the lock button on the door. **A sound from the lock will be audible at this time.**

Please note that this function will not unlock the doors if the engine is running.

pg. 46 Remote keyless entry system

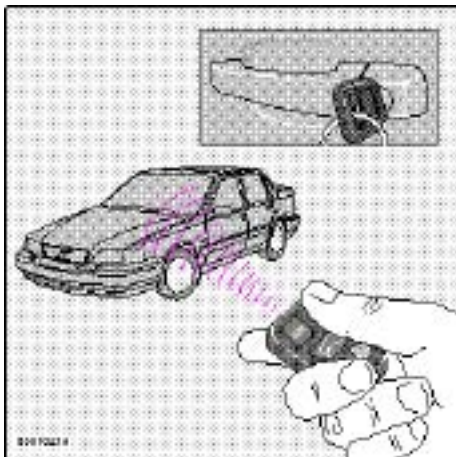

Remote keyless entry system

Your car is equipped with a remote control transmitter. This transmitter uses a radio frequency which will allow "keyless" entry into the passenger compartment or the trunk. You will be supplied with two coded key ring transmitters, which will enable you to lock/unlock all doors and the trunk/tailgate from a distance of 10-15 feet (3-5 meters).

On vehicles equipped with an alarm, the alarm will also be activated/deactivated by this system.

The car can also be locked/unlocked with the key.

As an extra security precaution in certain situations (valet parking, etc.), Volvo recommends that the transmitter not be included when the keys are given to anyone. The service key can be used instead. If one of the transmitters is misplaced, contact the nearest authorized Volvo retailer for assistance.



Using the remote control

- Press the **LOCK** button once to lock all doors and trunk/tailgate.
- Press the **UNLOCK** button **once** to unlock the driver's door only. Press this button again (within 10 seconds) to unlock all doors, trunk/tailgate.
- Press the **OPEN trunk/tailgate** button *twice* within 3 seconds to pop open the trunk or unlock the tailgate.

NOTE: To avoid leaving your keys in the car, make a habit of always locking the car with the remote control.

This device complies with FCC rules Part 15. Operation is subject to the following two conditions: (1) This device may not cause harmful interference and (2) this device must accept any interference that may be received, including interference that may cause undesired operation.

NOTE: If only the driver's door is unlocked, the lock will automatically reengage (re-lock) and the alarm will reset after 2 minutes unless the door has been opened.

The lock/unlock and alarm features can also be utilized by using the keys. See section: Doors and Locks

on [page 45](#).

If the alarm LED glows continuously for 5 seconds, this indicates a fault in the system or that a door is not properly closed.

WARNING!

Volvo does not recommend using the transmitter to lock the doors from inside the car. On cars equipped with an alarm, the alarm would be activated and would sound when one of the doors is opened. The doors must not be locked using the remote transmitter while the vehicle is occupied. In case of an accident, this may hinder rapid access to the occupants of the vehicle. The alarm will also sound on models equipped with this feature.

pg. 47 Alarm (certain models)

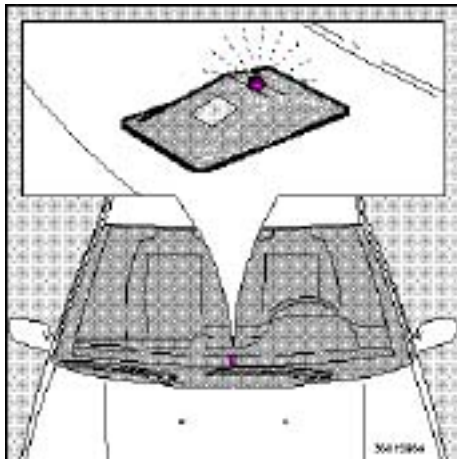

LED alarm status indicator

Alarm

The radio signal emitted from the transmitter, which is used to set/unset the alarm, is a "rolling code" signal. This means that the signal is changed randomly for each transmission and is intended to help prevent unauthorized recording of the code.

When armed (set), the alarm continuously monitors a number of points on the car. The following conditions will set off the alarm:

- The hood is opened
- The trunk/tailgate is opened
- A door is opened
- The ignition switch is tampered with
- The car is lifted or towed (if the car is equipped with the optional inclination sensor)
- The battery is disconnected (if the car is equipped with the optional backup battery siren). The alarm

will sound for ten 30 second intervals, with a 5 second pause between intervals. This function cannot be interrupted.

Arming (setting) the alarm

Press the LOCK button on the remote control, lock the car using the key in the driver's door or press the central lock button on one of the front doors with the door open. One long flash of the turn signals will confirm that the alarm is set.

Disarming the alarm

Press the UNLOCK button on the remote control or unlock the doors with the key.

Turning off (stopping) the alarm

If the alarm is sounding, it can be stopped by pressing the UNLOCK button on the remote control or by unlocking the driver's door with the key.

If the alarm is stopped with the remote control, this will be confirmed by two short flashes from the turn signals.

Visual alarm signal

The visual alarm signal is given by flashing all turn signals and turning on the interior lighting for approximately 5 minutes.

Audible alarm signal

An audible alarm signal is given either by a separate alarm horn or by the optional back-up siren. One alarm cycle lasts for 30 seconds.



"Panic" function

In an emergency situation, this feature can be used to attract attention.

Activate the "panic" function by pressing the red panic button on the remote control for at least 3 seconds or by pressing this button twice within 3 seconds. The turn signals will flash, the interior lights will go on and the alarm will sound.

The function can be turned off by pressing any of the buttons on the remote control or will stop automatically after 25 seconds.

NOTE: This button will **NOT** unlock the car.

pg. 48 Alarm

LED alarm status signals

The status of the alarm system is indicated by the red LED at the top center of the dash:

- LED off - the alarm is not armed (set)
- LED flashes once per second - the alarm is armed (set)
- LED flashes rapidly before the ignition is switched on - the alarm has been triggered
- LED flashes rapidly for 15 seconds after the ignition has been switched on - a fault has been detected in the alarm system. Contact a Volvo retailer.

Automatic reset function

If only the driver's door is unlocked with the remote control, the lock will automatically reengage (re-lock) and the alarm will reset after 2 minutes unless the door has been opened.

Temporarily disconnecting the alarm sensor(s)

In certain situations it may be desirable to disconnect the **optional** alarm sensors, particularly the inclination sensor, if, for example, you drive your car onto a ferry where the rocking of the boat could trigger the alarm.

To temporarily disconnect the sensor(s) from the alarm system:

- With all doors closed, switch off the ignition and remove the key from the ignition switch
- Press the locking (left) side of the central locking button on the driver's door for at least 3 seconds
- The doors will first lock and then unlock after 3 seconds to confirm that the sensors have been disconnected

The car can then be locked in the usual way to set the alarm.

NOTE: The sensors will automatically be reconnected to the alarm system the next time the ignition is switched on.

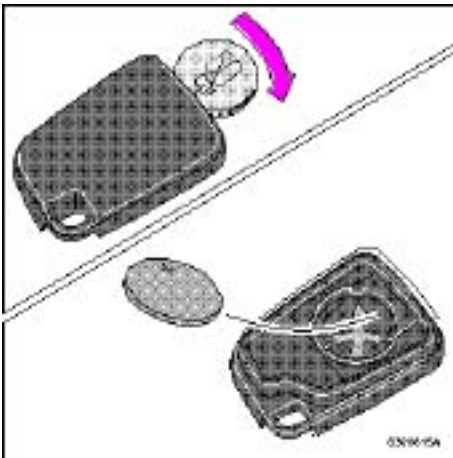

Batteries

Each remote transmitter is powered by a three-volt battery, type CR 2016. If the range of the transmitter is noticeably reduced, this indicates that the battery is weak and should be replaced.

Replacement: Remove the battery cover on the back of the transmitter with a coin. Replace the battery. Reinstall the cover, making sure it is secured tightly to help protect the transmitter.

CAUTION: Do not attempt to service or repair any components of the alarm system yourself. This should only be done by an authorized Volvo retailer.

pg. 49 Trunk/Tailgate

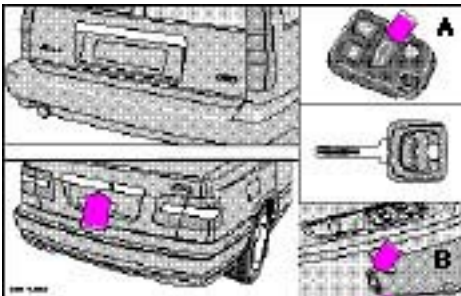

Unlocking the trunk/tailgate

The trunk/tailgate locks are incorporated in the central locking system and are locked or unlocked when the driver's door is locked/unlocked.

The trunk can be unlocked by:

- Pressing the button on the remote control (A) **twice**
- Using the master key in the trunk

- Using the trunk/tailgate control on the driver's door (B)

Refer to [page 44](#) for information on the remote control locking system.

Disconnecting the trunk lock

The trunk lock can also be disconnected from the central locking system by turning the key counterclockwise as shown below:

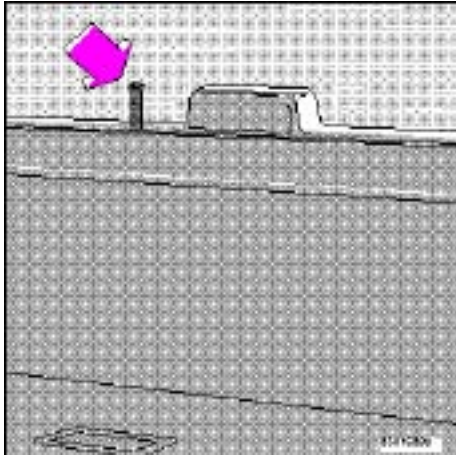

Withdraw the key in the horizontal position ***

The trunk is now always locked. The optional folding rear seatback can also be locked from the trunk (see page 57). This feature can be used for e.g., valet parking. If you give only the service key to the driver, it will not be possible to gain access to the trunk. Please be aware that this setting may preclude access to the spare tire and jack.

To reconnect the lock to the central locking system:



Withdraw the key in the vertical position

*** In this position, the trunk cannot be opened with the control on the driver's door or the remote control.



Unlocking tailgate from the inside

Tailgate lock button

If the doors and tailgate are locked, the tailgate can be unlocked from the inside by pulling up the lock button (see illustration). This unlocks the tailgate only. **Please note that this button will only function if the child safety lock in the tailgate is *disengaged*** (see [page 50](#)).

WARNING!

Do not drive with the tailgate open! Poisonous exhaust gases may enter via the open tailgate.

pg. 50 Child safety locks (sedan/wagon)

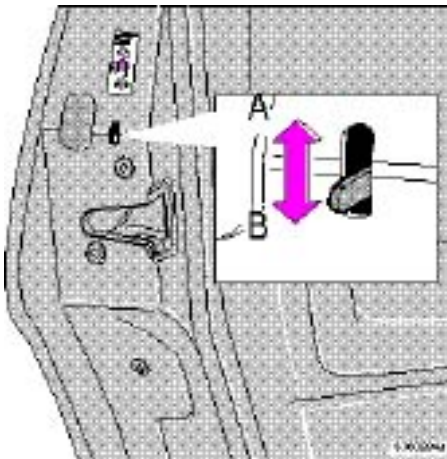

Location and setting of child safety lock

Child safety locks (sedan/wagon)

The controls are located on the rear door jambs.

A The door cannot be opened from the inside. Normal operation from the outside.

B The door lock functions normally.

WARNING!

Remember, in the event of an accident, the rear seat passengers cannot open the doors from the inside with the buttons in position A.

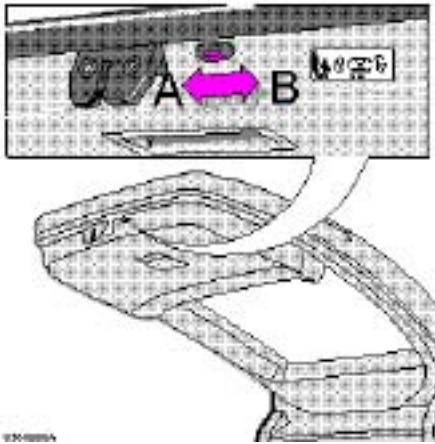

Child safety lock in tailgate

Child safety lock (wagon - certain models)

The tailgate incorporates a safety catch which is located to the side of the lock.

A The tailgate cannot be opened from the inside.

B The tailgate functions normally.

NOTE: You must use the end of a key, screwdriver, etc. to move the child safety lock.

WARNING!

Remember, in the event of an accident, the tailgate cannot be opened from the inside when the safety catch is in position A.



[Contents](#) | [Top of Page](#)

2000 VOLVO S & V70

pg. 51 Front seats

1 Height adjustment (manual)

The front section of both front seats can be adjusted to eight different height settings and the rear section of both seats can be adjusted to nine different height settings.

Front lever = adjustment of front section

Rear lever = adjustment of rear section

WARNING!

Do not adjust the seat while driving. The seat should be adjusted so that the brake pedal can be depressed fully. In addition, position the seat as far rearward as comfort and control allow. The seat rails on the floor must not be obstructed in any way when the seat is moved.

2 Forward-rearward seat adjustment (manual)

Pull the control upward, then slide the seat forward or rearward to the desired position. Make sure that the seat is properly secured when you release the control.

Folding front seat

The passenger's seat backrest has a quick forward release mechanism which can be used when long loads are carried. See [page 63](#).

3 Backrest tilt (manual)

Rotate the control counterclockwise to tilt the backrest rearward and clockwise to tilt the backrest forward.

4 Lumbar support *

Firm: turn clockwise.

Soft: turn counterclockwise.

* Driver's seat only on certain models

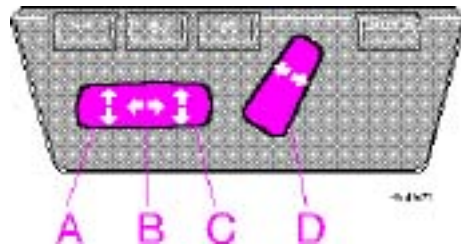

Electrically operated seats with memory function (certain models)

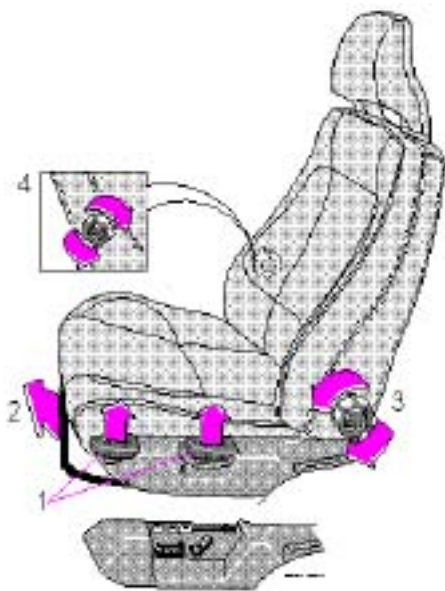

Power seat control panel

A Seat front (raise/lower)

B Forward - rearward

C Seat rear (raise/lower)

D Backrest tilt

WARNING!

The power driver's seat is operable with the ignition OFF. Therefore, children should never be left unattended in the car.

Movement of the seat can be STOPPED at any time by pressing any button on the power seat control panel.

To adjust the passenger's seat, the ignition key must be in position I or II.

Refer to the following page for information on programming the memory function.

pg. 52 Electrically operated driver's seat, Rear/side-view mirrors

Programming the memory

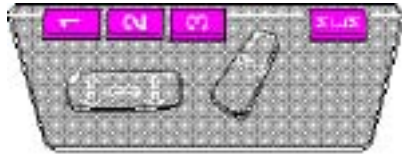

Three seat positions can be programmed. To program a seat position:

- 1 Adjust the seat to the desired position.
- 2 Depress the MEM button.
- 3 Press button 1 to program the current position of the seat.

Buttons 2 and 3 can be programmed in the same way. To move the seat to a programmed position, depress button 1, 2 or 3 until the seat stops. If the button is released before the seat has reached the programmed position, the seat will stop as a safety precaution.

NOTE: The seat has an overload protector which engages if an object blocks the movement of the seat. If this happens, remove the object and wait 20 seconds before operating the seat again.

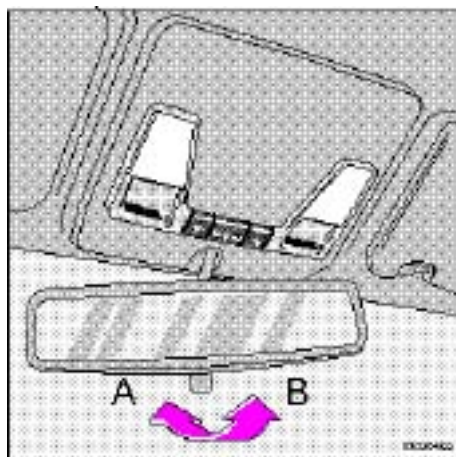

Rear-view mirror

A Normal position

B Night position, reduces glare from following headlights

CAUTION: Never use ice scrapers made of metal as they can easily scratch the mirror surface.

WARNING!

The mirrors should always be adjusted prior to driving. Objects seen in the wide-angle right side-view mirror are closer than they appear to be.

Selector button

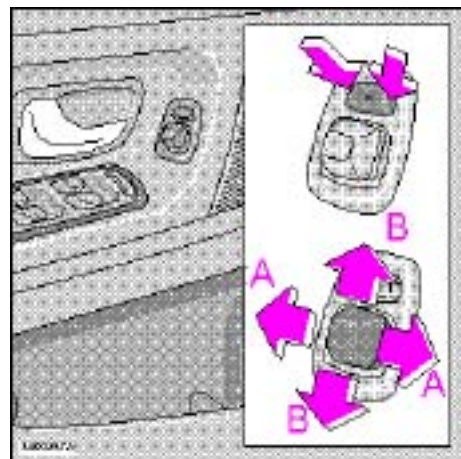

Adjustment control

Electrically operated side-view mirrors

The mirror control switches are located on the driver's door armrest. Press the left side of the selector button and then use the adjustment control to adjust the driver's door mirror. Press the right side of the selector button before adjusting the passenger door mirror.

A Horizontal adjustment

B Vertical adjustment

pg. 53 Interior lights, Vanity mirror

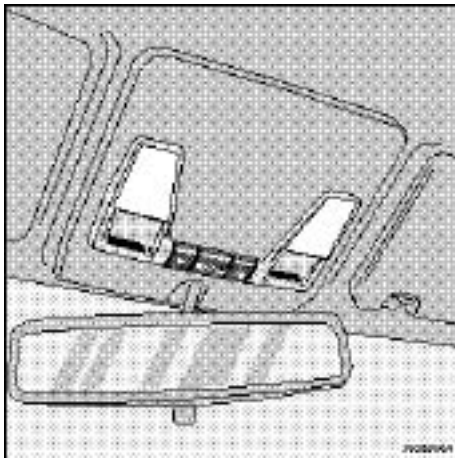

Front courtesy lights

The front courtesy lighting consists of two reading lights for the front seat occupants.

- Front and rear reading lights always on
- Front and rear reading lights always off
- Front and rear reading lights come on when a door is opened
- Left or right reading light illuminates if the center switch is in position .

The courtesy lights remain illuminated for 30 seconds after the doors have been closed but will be switched off if the ignition is turned on or the doors are locked.

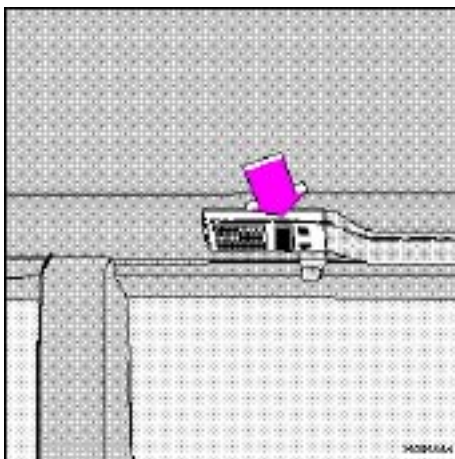

Reading lights, rear seat

There are two reading lights for the rear seat passengers. These are turned on/off by using the adjacent switches.

Light is on if the front switch is in position .

Light turns on if any door is opened.

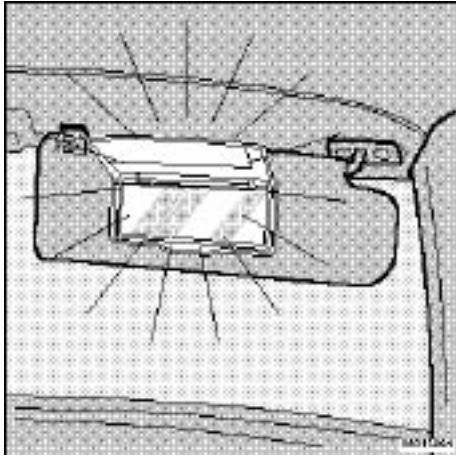

Vanity mirrors

The light illuminates when the cover is opened.

The driver's side vanity mirror will only illuminate if the ignition key is in position I.

pg. 54 Sun roof (option)

Ventilation position

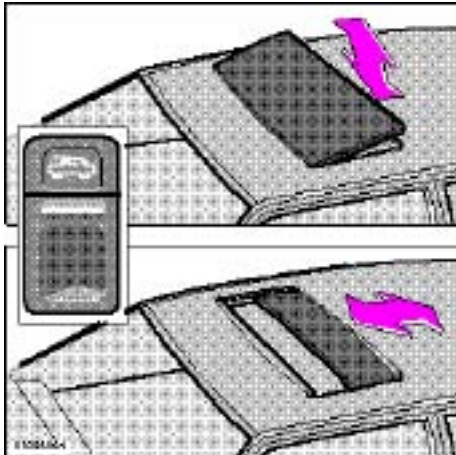

Sliding sun roof

Electrically operated sun roof

The switch for operating the sun roof is located on the instrument panel. The starting

(ignition) key must first be turned to position II. On certain models, the sun roof is equipped with a one-touch, AUTO-open function.

- **AUTO-open:** Press the lower section of the switch once to automatically open the sun roof to the "comfort position" *. Press again to open the sun roof completely.

The AUTO-open function can be stopped at any time by pressing the switch.

- **To close the sun roof:** Depress the upper section of the switch *until the sun roof has closed completely*.

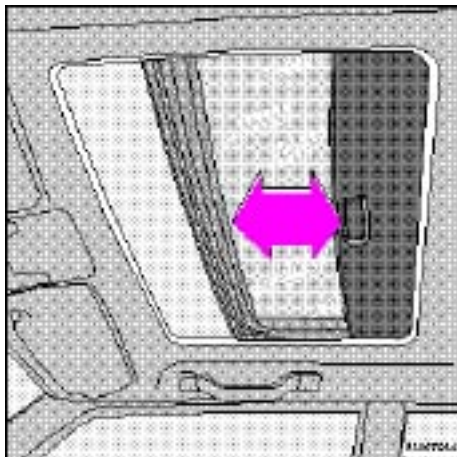

Sun visor

- **To open the rear edge of the sun roof (ventilation position):** With the sun roof closed, depress the upper section of the switch. To close, depress the lower section of the switch until the sun roof has closed completely.

- **To slide open the sun roof :** Depress the lower section of the switch until the sun roof has opened to the position you prefer or hold the switch until the sun roof reaches the "comfort position" *. Depress the lower section of the switch again to open the sun roof completely.

Sun visor: The sun roof also features a sliding sun visor. The visor slides back automatically when the sun roof is opened and also slides back slightly when the sun roof is opened to the ventilation position. The visor must be closed manually.

CAUTION: Do not close the sun visor when the sun roof is in the ventilation position as this could damage the mechanism.

NOTE:

The electrically operated sun roof has an overload protecting circuit breaker (fuse no. 37) which is activated when an object blocks the sun roof. Should this occur, remove the object and wait 20 seconds for the circuit breaker to reset. The sun roof should then function normally. Also check fuse no. 35.

WARNING!

The sun roof must never be obstructed in any way when in operation.

* A position where the sun roof is not quite fully open. This position helps alleviate "rumbling" wind noise.

pg. 55 Hood

Hood release lever under dashboard

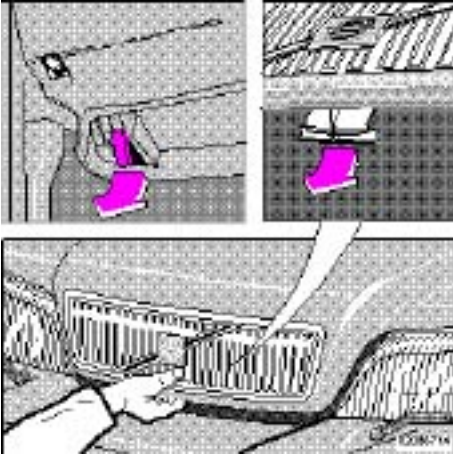

Hood release control under grille

To open the hood

- Pull the lever located under the left side of the dash to release the hood locks.
- Lift the hood slightly.
- Pull the release control on the inside of the lower edge of the grille toward you and lift the hood.

WARNING!

Check that the hood locks properly when closed.

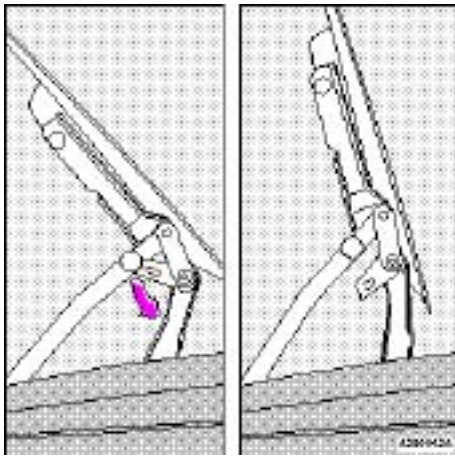

The hood normally opens to an angle of 57°. The hood can be opened to the vertical position by rotating the hinge catches (see illustrations). The catches will return to their normal positions when the hood is closed.

Ensure adequate clearance in low-roof garages to avoid damaging the hood.

pg. 56 Storage compartments

WARNING!
 Packages on the rear window shelf can obscure vision and may become dangerous projectiles in the event of a sudden stop or an accident.

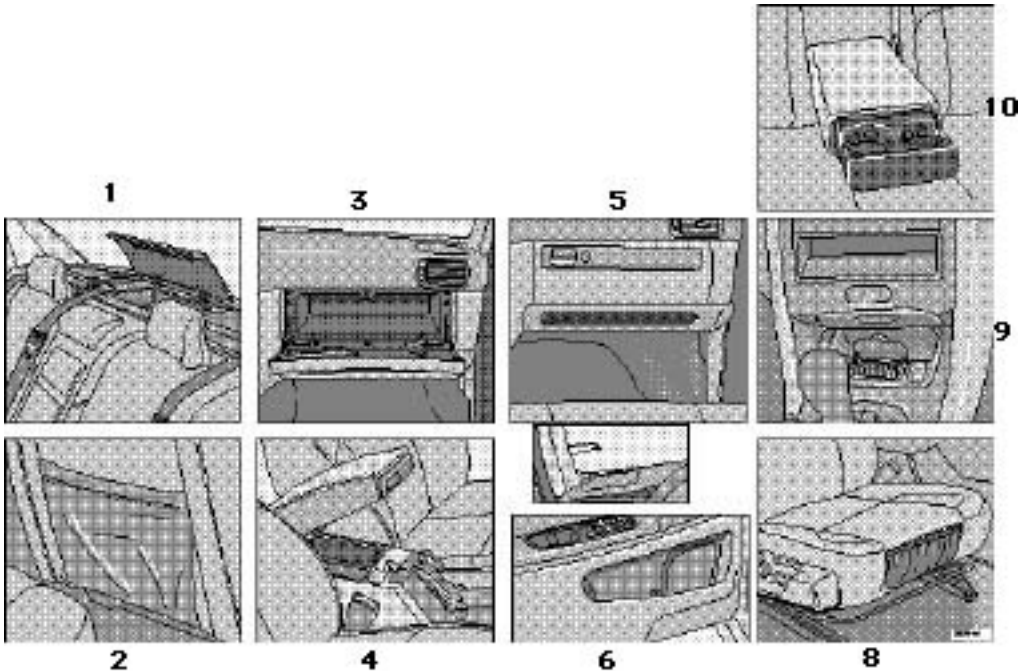

1 Compartment in hat shelf (sedan)

- 2 Pocket on rear of front seat
- 3 Glove compartment
- 4 Compartment between front seats/Cup holder (certain models)
- 5 Shelf under glove compartment
- 6 Compartment in door (certain models)
- 7 Clip for parking receipts
- 8 Pocket in seat front (certain models)
- 9 Coin holder
- 10 Rear cup holder

pg. 57 Trunk light, Spare tire, Jack (sedan)

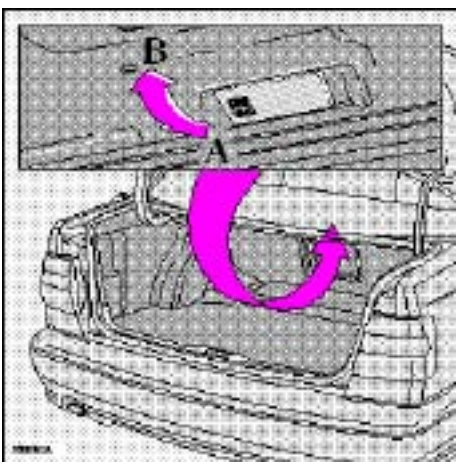

Trunk light

A Light always off

B Light is on when the trunk lid is open

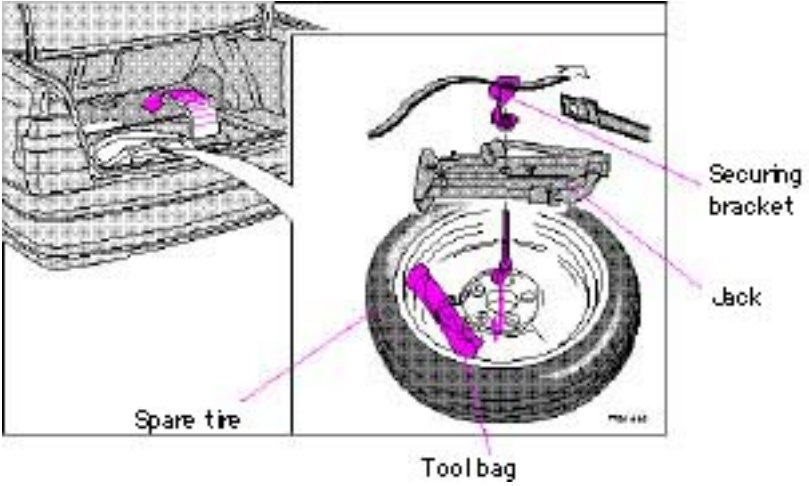

Spare tire

The spare tire is located under the carpet in a special well under the floor of the trunk. The jack is placed inside the wheel rim.

WARNING!

Make sure that the jack is properly secured in the wheel rim with the securing bracket. The belt must also be threaded through the slot in the securing bracket (see illustration) and properly fastened to help keep the spare wheel/jack in place in the event of a sudden stop.

NOTE: See [pages 94-95](#) for information on how the jack should be used.



[Contents](#) | [Top of Page](#)

2000 VOLVO S & V70

pg. 58 Cargo space lighting, Spare tire, Jack (wagon)

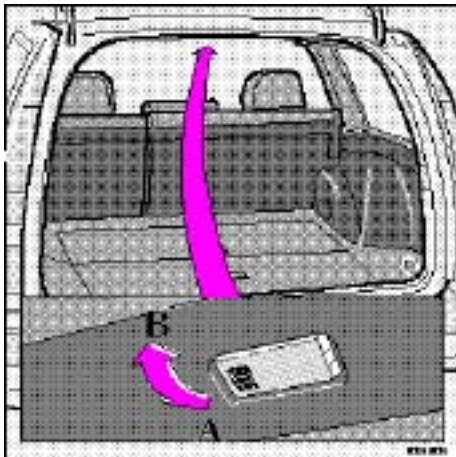

Cargo space lighting

There is an extra courtesy light at the rear of the cargo space.

A The light is always OFF.

B Light comes on when the tailgate is opened.

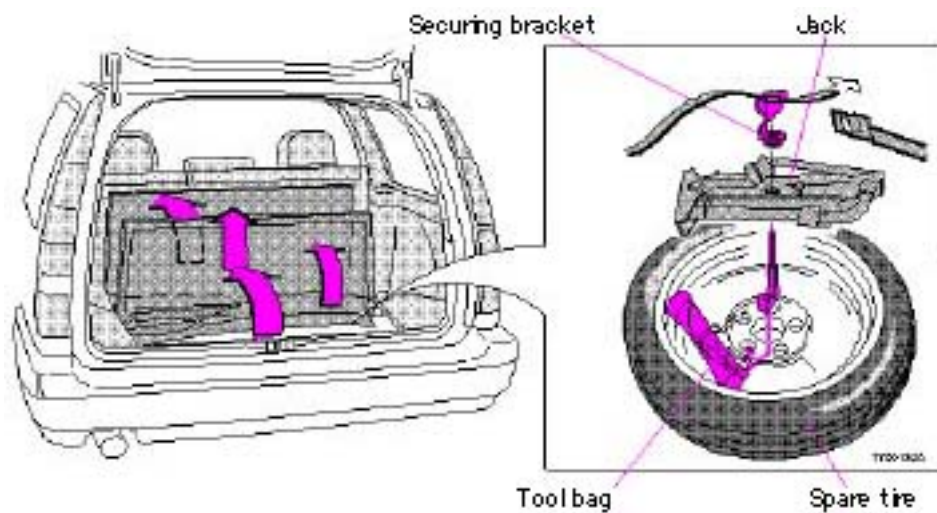

Spare tire and jack

The spare tire and the jack are located beneath the floor mat in the large storage bin.

WARNING!

Make sure that the jack is properly secured in the wheel rim with the securing bracket. The belt must also be threaded through the slot in the securing bracket (see illustration) and properly fastened to help keep the spare wheel/jack in place in the event of a sudden stop.

NOTE: See [pages 94-95](#) for information on how the jack should be used.

pg. 59 Folding rear seat (sedan)

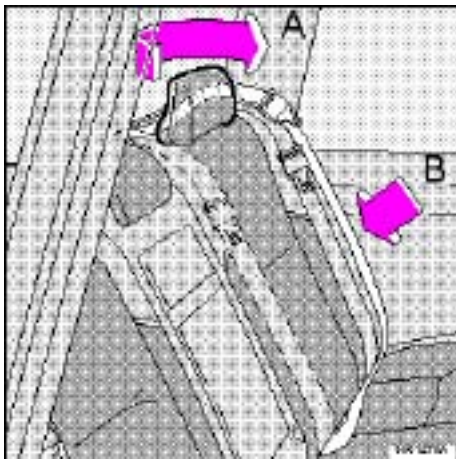

Folding rear seat

The rear seat is split into two sections so that each section can be folded independently.

- Lift the rear seat belts to the fixed section of the backrest. The center seat belt can also be folded across the fixed part of the backrest so that it does not get in the way if the right-hand backrest is folded down (see illustration above).
- Pull the catch forward and fold the backrest down.

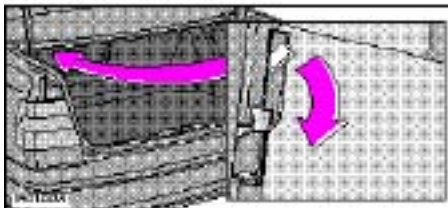

Locking levers

The two red levers on the rear side of the backrests can be used to bypass the folding

mechanism and prevent the backrests from being folded down from inside the car. Push the levers down to lock the backrests in the upright position. This function can be used to limit access to the trunk.

· When folding the backrests up, make sure the seat belts return to their normal positions.

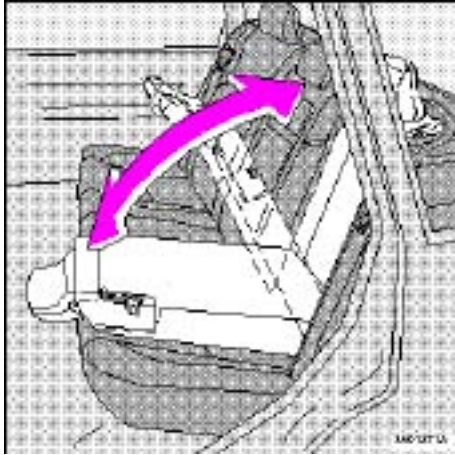

WARNING!

When the backrest is returned to the upright position, check that it is properly locked in place.

NOTE: If the backrest is folded down for prolonged periods, the seat belt locks could be covered (i.e., with a towel) to help avoid marks on the backrest upholstery.

pg. 60 Folding rear seat (wagon)

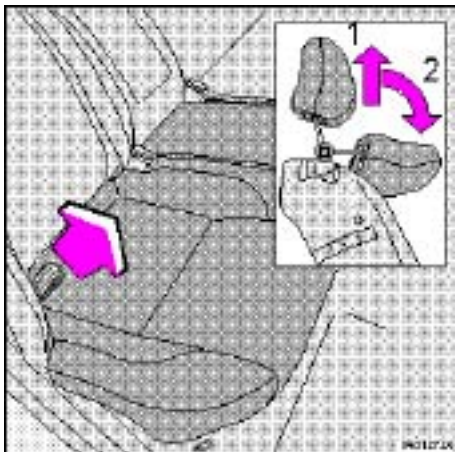

Seat cushion strap

Folding rear seat (wagon)

The rear seat is split into two sections so that each section can be folded independently.

- Straighten front seat backrests if they are tilted too far to the rear.
- Pull the strap to lift the rear seat cushion and swing the cushion up and toward the back of the front seats.
- The outboard head restraints must be lowered before the backrest is folded down (see inset illustration above):

1 - pull straight up, **2** - fold forward.

- Push the center head restraint straight down if it has been raised.
- Move the backrest release lever rearward and fold the backrest down.

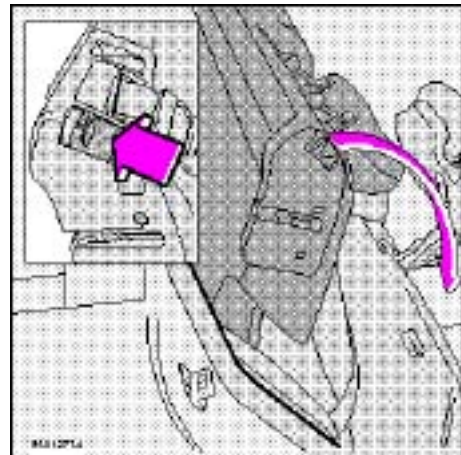

Release lever - backrest

- Check that the hooks under the seat cushions engage the holes on the top edge of the backrest.

When the backrest is raised, the outboard head restraints must be returned to their normal positions.

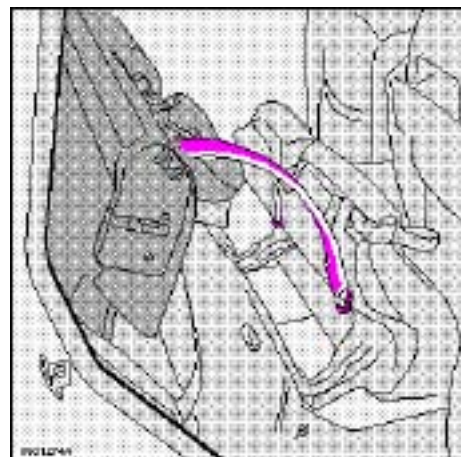

Hooks fit into holes

The backrest must lock into place. **The red lock indicator will not be visible if the seat has locked into place correctly.**

The seat belts must be correctly positioned when the seat is returned to the normal position.

WARNING!

When the rear seat is folded down, do not place heavy objects against the backs of the front seats. This places a severe strain on the folded down backrest of the rear seat. Be sure to secure cargo. Cargo must not be stacked higher than the top of seatbacks. This will reduce the possibility of luggage, etc. becoming projectiles during sudden maneuvers, rapid braking or an accident.

pg. 61 Folding rear seat, Removing seat cushions (wagon)



WARNING!

The **red lock indicator** is **VISIBLE** (A) when the backrest is **NOT** locked in position and not visible (B) when the backrest is correctly locked in place. When the backrest is in the upright position, it must always be correctly locked in place.

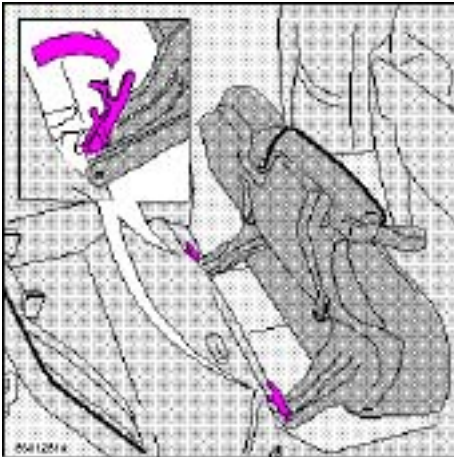

Removing seat cushions

The seat cushion can be easily removed to provide a slightly larger cargo storage area.

- Fold the seat cushion toward the back of the front seats
- Release the red catches
- Disconnect the connector for the rear seat heating (certain models)

- Fold the cushion back to a nearly horizontal position
- Lift out the cushion

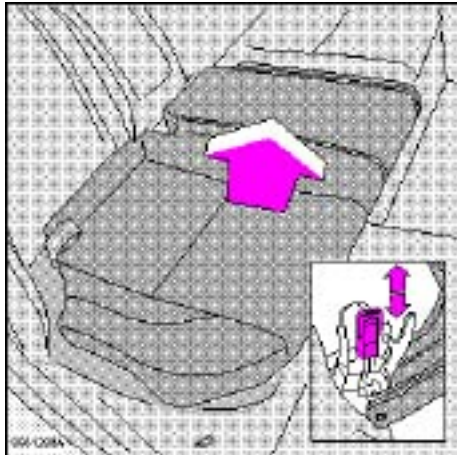

WARNING!

Do not place extremely heavy articles against the front seats, as the backrest which is folded down is then placed under severe strain.
Be sure to secure cargo. Hard and sharp articles could otherwise damage the front seat backrest and/or cause injury to passengers in the event of rapid braking or a collision.

pg. 62 Concealed storage bin (wagon), Bumper cover (wagon), Avoiding battery drain

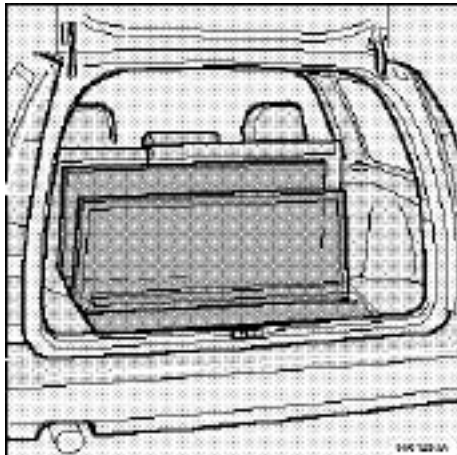

The lid of the storage compartment is hinged in the middle

Concealed storage bin

The storage compartment under the floor of the cargo space is hinged in the middle and can be locked with a key.

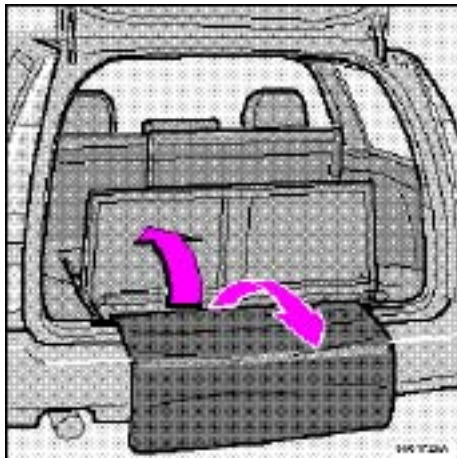

Bumper cover (certain models)

A bumper cover is located in the concealed storage bin. This cover can be folded out when loading/unloading the cargo compartment to protect your clothing and to help protect the bumper from scratches.

The bumper cover can also be used to protect the floor of the storage bin from muddy shoes, etc. if the optional auxiliary child seat is being used.

The bumper cover is attached by a velcro strip and can easily be removed for cleaning.

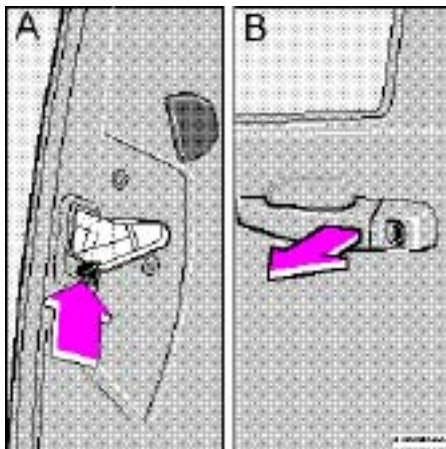

To avoid battery drain

The courtesy lights and the warning lights in the rear of the doors come on when a door is opened.

- To avoid battery drain when the doors are opened for prolonged periods, these lights can be switched off by pressing the lock mechanism (A) located in the rear facing side of the driver's door.
- To return the lights to their normal function, pull the door handle out before closing the door (B) and use a small screwdriver to push the lock mechanism back to its original position.

pg. 63 Luggage net, Side cargo net - wagon (certain models)

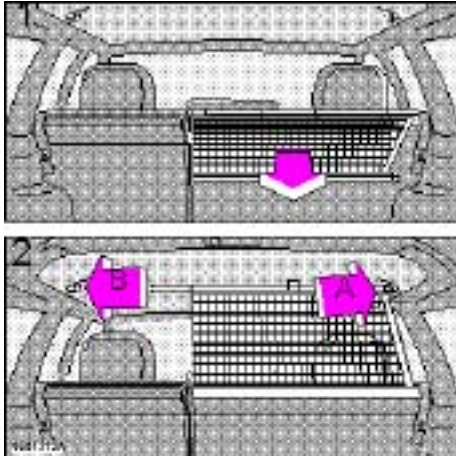

Luggage net (option)

The luggage net helps prevent cargo from being thrown forward should the vehicle stop suddenly or be involved in an accident.

The net unreels from the rear upper edge of the rear seat backrest and must be accessed from the cargo compartment.

1 Open the cover on the passenger side seat back and pull the luggage net toward you.

2 Hook the rod onto the bracket on the right side ceiling (A).

Pull out the left side of the rod and attach it to the bracket on the driver's side ceiling (B).

3 Unreel the driver's side luggage net.

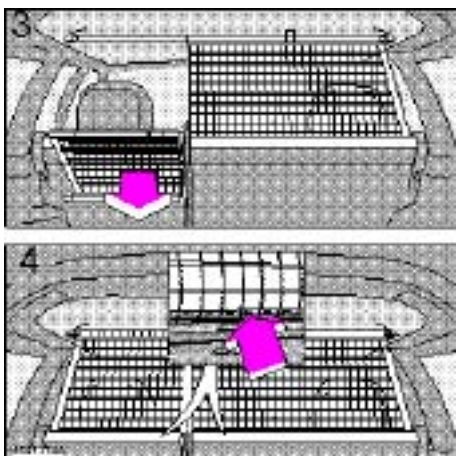

4 Hook it to the rod.

Make sure the nets are securely attached to the hooks under the covers and pulled taut.

Use the reverse procedure to retract the net.

NOTE: The luggage net can also be used when the rear seat is folded down. However, extra brackets (optional) must be installed on the upper rear door hand grips.

WARNING!

If your car is equipped with an auxiliary child seat in the cargo compartment, the cargo net must be retracted before using the child seat. Otherwise, in the event of a sudden stop or accident, the child could be injured and the net could hinder rapid access to the cargo compartment.

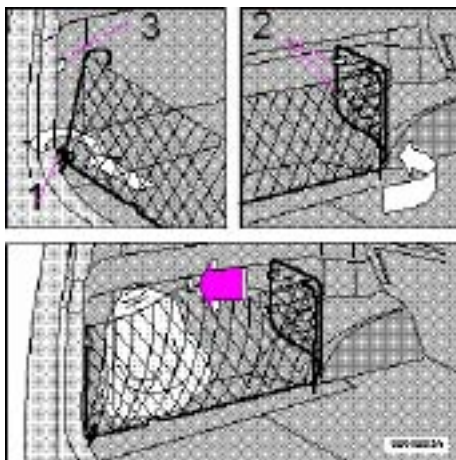

Side cargo net

To install the side cargo net, slide the rounded hook on the net through the cargo eyelet (1), slide the wire frame of the net into the clips provided and press the lower wire into the hole in the floor (2) and secure the upper rear corner of the cargo net in the clip (3).

WARNING!

Never use this net to secure sharp or heavy objects. In such cases, tie down the object using the cargo eyelets in the cargo compartment. The net should not be used if the optional auxiliary child seat is occupied. The side cargo net should only be used in combination with the luggage net.

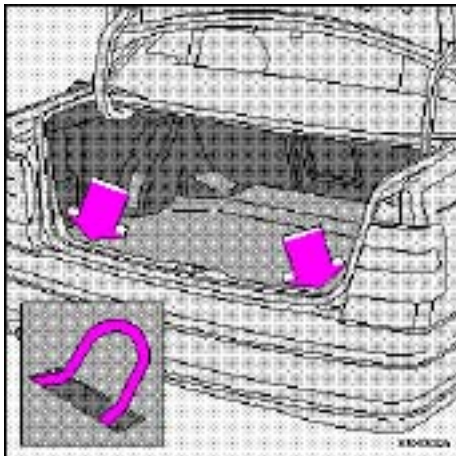

Eyelets in trunk (sedans)

Securing cargo

As a safety precaution, your car is equipped with two eyelets in the trunk (four in the cargo space on wagons) to which straps can be attached to secure luggage.

WARNING!

The eyelets are not to be used as passenger restraints or as anchorages for child restraints. See page 14.

Wagons only:

Unless the station wagon is equipped with Volvo's auxiliary seat for children (option) passengers should not ride in the rear cargo area.

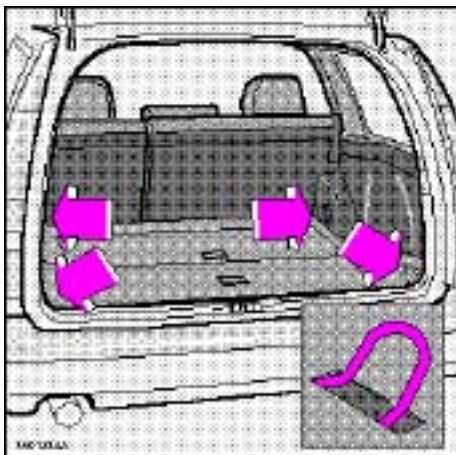

Eyelets in cargo area (wagons)

Wagons only:

If the optional auxiliary seat for children is in use, fold this seat down **before** folding down

the rear seat backrest.

Remember that a 44 lbs object weighs the equivalent of 2,200 lbs in a headon collision at 30 mph!

Remember the following when loading the car:

- Load the cargo **against** the backrest.
- Load heavy cargo as low down as possible.
- Load wide cargo on either side of the rear seat split.
- Secure the cargo with cargo straps through the eyelets in the cargo space.
- If nobody is sitting in the rear seat reinforce the backrest by fastening the rear seat belts.
- Never load cargo above the backrest without a cargo net.

pg. 65 Folding front seat (sedans/wagons), Long load storage (sedans)

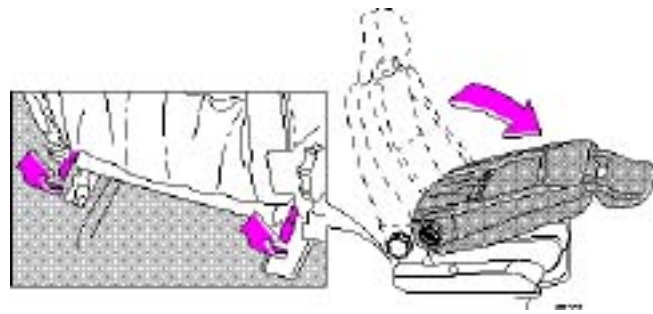

Folding front seat (certain models)

The passenger seat backrest can be folded down to the horizontal position for carrying long loads. To fold down the backrest:

- Move the seat as far rearward as possible
- Adjust the backrest tilt to the most upright position
- Lift the catches on the lower rear side of the backrest
- Without releasing the catches, push the backrest forward
- Move the seat as far forward as possible

WARNING!

Cover sharp edges on the load to help prevent injury to occupants. Secure the load to help prevent shifting during sudden stops.

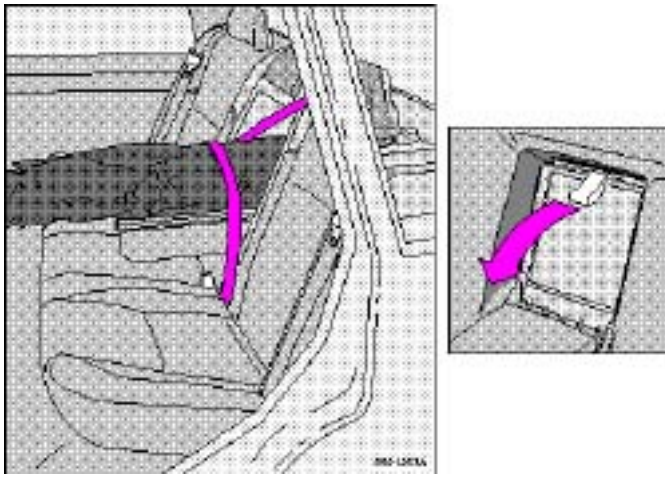

Long load storage (sedans)

There is a flap located in the panel behind the rear seat which makes it possible to carry long loads such as skis, etc. To open, pull the strap forward. If your car is equipped with the optional integrated booster cushion, this cushion must be folded down first.

Protective covers (for skis) should be used to avoid soiling or tearing the upholstery. Please note that the flap in the rear seat is only intended for light loads such as skis, carpets, etc.

Max length: 6 1/2 ft (2 meters) Max weight: 55 lbs (25 kg)

WARNING!

Always turn the engine off and apply the parking brake when loading/unloading the vehicle. Place the transmission in the P (PARK) position to help prevent inadvertent movement of the gear selector.



2000 VOLVO S & V70

Chapter 4 - Starting and driving

pg. 67 Starting and driving

This section on starting and driving contains items such as starting the engine, operating the gear selector, towing, trailers, etc.

Fuel requirements, Refueling	<u>68-</u> <u>69</u>
Driving economy	<u>70</u>
Starting the engine	<u>71</u>
Manual transmission	<u>72</u>
Automatic transmission, All Wheel Drive (AWD)	<u>74-</u> <u>77</u>
Points to remember	<u>78-</u> <u>79</u>
Emergency towing	<u>80</u>
Vehicle towing information	<u>81</u>
Jump starting	<u>82</u>
Brake system, ABS	<u>83</u>
TRACS/STC	<u>84</u>
Winter driving	<u>85</u>
Trailer towing	<u>86</u>

pg. 68 Fuel requirements

NOTE ENGINE OIL:

Although some oil consumption occurs during normal engine operation, more oil is consumed when the engine is new as the internal parts generate higher friction while wearing in to each other. **From the time the engine is new until the first service is performed, the oil consumption could be higher than normal. For this reason, it is especially important to check the oil every time you refuel your car during this period. See [page 126](#).**

In general, the rate of oil consumption depends on such factors as: engine temperature, length of trip, driving conditions, oil viscosity and quality, engine speed and acceleration/deceleration.

Checking your engine oil level each time the car is refueled is one of the most important items you can perform to help keep your car in good running order.

Deposit control gasoline (detergent additives)

Volvo recommends the use of gasoline containing deposit control additives. These additives have shown to be efficient in keeping injectors and intake valves clean. Consistent use of deposit control gasolines will help ensure good driveability and fuel economy. If you are not sure whether the gasoline contains deposit control additives, check with the service station operator.

Unleaded fuel

Each Volvo has a three-way catalytic converter and must use only unleaded gasoline. U.S. and Canadian regulations require that pumps delivering unleaded gasoline be labelled "UNLEADED". Only these pumps have nozzles which fit your car's filler inlet. It is unlawful to dispense leaded fuel into a vehicle labelled "unleaded gasoline only". Leaded gasoline damages the three-way catalytic converter and the heated oxygen sensor system. Repeated use of leaded gasoline will lessen the effectiveness of the emission control system and could result in loss of emission warranty coverage. State and local vehicle inspection programs will make detection of misfueling easier, possibly resulting in emission test failure for misfueled vehicles.

NOTE: Some U.S. and Canadian gasolines contain an octane enhancing additive called methylcyclopentadienyl manganese tricarbonyl (MMT). If such fuels are used, your Emission Control System performance may be affected, and the Malfunction Indicator Lamp located on your instrument panel may light. If this occurs, please return your vehicle to an authorized Volvo retailer for service.

pg. 69 Fuel requirements, Refueling

Octane rating

Volvo engines are designed for optimum performance on unleaded premium gasoline with an octane rating. AKI of 91, or above. AKI (ANTI KNOCK INDEX) is an average of the Research Octane

Number, RON, and the Motor Octane Number, MON. (RON + MON/2).

The minimum octane requirement is AKI 87 (RON 91).

Gasoline containing alcohol and ethers

"Oxygenated fuels"

Some fuel suppliers sell gasoline containing "oxygenates" which are usually alcohols or ethers. In some areas, state or local laws require that the service pump be marked indicating use of alcohols or ethers. However, there are areas in which the pumps are unmarked. If you are not sure whether there is alcohol or ethers in the gasoline you buy, check with the service station operator. To meet seasonal air quality standards, some areas require the use of "oxygenated" fuel.

Volvo allows the use of the following "oxygenated fuels; however, the octane ratings listed on this page must still be met.

Alcohol — Ethanol

Fuels containing up to 10% ethanol by volume may be used.

Ethanol may also be referred to as Ethyl alcohol, or "Gasohol".

Ethers — MTBE

Fuels containing up to 15% MTBE may be used.

Refueling

The fuel tank is designed to hold approximately:

18 US gal. (68 liters) - Front Wheel Drive

17.4 US gal (66 liters) - All Wheel Drive

with sufficient volume left over to accommodate possible expansion of the fuel in hot weather. Be aware that the "usable" tank capacity will be somewhat less than the specified maximum. When the fuel level is low, such factors as ambient temperature, the fuel's "Reid vapor pressure" characteristics, and terrain can affect the fuel pumps' ability to supply the engine with an adequate supply of fuel. Therefore, it is advisable to refuel as soon as possible when the needle nears the red zone, or when the fuel warning light comes on.

Fuel tank cover

The fuel tank cover (on the right rear fender) is locked and must be popped open using the control on the driver's door.

Open fuel filler cap slowly during hot weather conditions.

CAUTION:

- Do not refuel with the engine running *. Turn the ignition off or to position I. If the ignition is on, an incorrect reading could occur in the fuel gauge.
- After refueling, close the fuel filler cap by turning it clockWise until it *clicks* into place *.
- Allow for fuel expansion by not overfilling the tank. Overfilling could also cause damage to the emission control systems.
- Avoid spilling gasoline during refueling. Gasolines containing alcohol can cause damage to painted surfaces, which may not be covered under the New Vehicle Limited Warranty.
- Do not use gasolines containing methanol (methyl alcohol, wood alcohol). This practice can result in vehicle performance deterioration and can damage critical parts in the fuel system. Such damage may not be covered under the New Vehicle Limited Warranty.

** If the fuel filler cap is not closed tightly or if the engine is running when the car is refueled, the Malfunction Indicator Lamp may indicate a fault. However, your vehicle's performance will not be affected. Use only Volvo original or approved fuel filler caps.*

pg. 70 Driving economy

Economical driving conserves natural resources

Better driving economy may be obtained by thinking ahead, avoiding rapid starts and stops and adjusting the speed of your vehicle to immediate traffic conditions. Observe the following rules:

- Bring the engine to normal operating temperature as soon as possible by driving with a light foot on the accelerator pedal for the first few minutes of operation. A cold engine uses more fuel and is subject to increased wear.
- Whenever possible, avoid using the car for driving short distances. This does not allow the engine to reach normal operating temperature.
- Drive carefully and avoid rapid acceleration and hard braking.
- Do not exceed posted speed limits.
- Avoid carrying unnecessary items (extra load) in the car.
- Maintain correct tire pressure. Check tire pressure regularly (check when tires are cold).
- Remove snow tires when threat of snow or ice has ended.

- Note that roof racks, ski racks, etc., increase air resistance and thereby fuel consumption.
- Avoid using automatic transmission kickdown feature unless necessary.
- Avoid using the air conditioning when it is not required. When engaged, the air conditioner's compressor places an additional load on the engine. However, please note that fuel consumption is lower with the air conditioning on than it is when driving with the air conditioning switched off and the windows down.
- If your car is equipped with the optional Trip Computer, utilizing the fuel consumption modes can help you "learn" how to drive more economically.

Other factors which decrease gas mileage are:

- Worn or dirty spark plugs
- Incorrect spark plug gap
- Dirty air cleaner
- Dirty engine oil and clogged oil filter
- Dragging brakes
- Incorrect front end alignment

Some of the above mentioned items and others are checked at the standard Maintenance Service intervals.

NOTE: (D)rive or 5th gear (manual transmissions) should be used as often as possible to help improve fuel economy.

Before a long distance trip

It is always worthwhile to have your car checked at a Volvo retailer before driving long distances. Your retailer will also be able to supply you with bulbs, fuses, spark plugs and wiper blades for your use in the event that problems occur.

If you prefer to check the car yourself, please note the following:

- Check that engine runs smoothly and that fuel consumption is normal.
- Check engine oil, coolant levels, and for possible fuel leakage.
- Check transmission oil level.
- Check condition of drive belts.
- Check state of charge of battery.
- Examine tires carefully (the spare tire as well), and replace those that are worn. Check tire pressures.
- The brakes, front wheel alignment, and steering gear should be checked by your Volvo retailer only.
- Check all lights, including high beams.
- Reflective warning triangles are legal requirement in some countries.
- Have a word with your Volvo retailer if you intend to drive in countries where it may be difficult to obtain correct fuel.
- Consider your destination. If you will be driving through an area where snow or ice are likely to occur,

consider snow tires.

pg. 71 Starting the engine

Starting and stopping

1. Fasten the seat belt.

WARNING!

Before starting, check that the seat, steering wheel and mirrors are adjusted properly. Make sure the brake pedal can be depressed completely. Move the seat closer if necessary. Refer to section "front seats".

2. Apply the parking brake, if not already set. The gear selector (**automatic transmission**) is locked in the (P)ark position (**SHIFT LOCK**).

Manual transmission: the clutch must be fully depressed.

3. **Without touching the accelerator pedal**, turn the ignition key to the starting position. Allow the starter to operate for up to 5 seconds (turbo: 10 seconds). Release the key as soon as the engine starts. If the engine fails to start, repeat step 3.

For cold starts at altitudes above 6000 ft (1800 meters), depress the accelerator pedal halfway and turn the key to the starting position. Release the pedal slowly when the engine starts.

4. To release the gear selector from the (P)ark position (automatic transmission), the ignition key must be in position II and the brake pedal must be depressed. **See page 108 for instructions on manually releasing the SHIFTLCK system.**

Do not race a cold engine immediately after starting. Oil flow may not reach some lubrication points fast enough to prevent engine damage.

NOTE: (Automatic transmission only)

Your car is equipped with a **KEYLOCK** system. When the engine is switched off, the gear selector must be in the (P)ark position before the starting key can be removed from the ignition switch.

5. Select the desired gear. The gear engages after a slight delay (automatic transmission) which is especially noticeable when selecting R.

CAUTION: (Automatic transmission only)

The engine should be idling; never accelerate until after you feel the gear engage! Too rapid acceleration immediately after selecting a gear will cause harsh engagement and premature transmission wear.

NOTE: Selecting P or N (automatic transmission) when idling at a standstill for prolonged periods of time will help prevent overheating of transmission oil.

WARNING!

Always place the gear selector (automatic transmission) in Park and apply the parking brake before leaving the vehicle. Never leave the car unattended with the engine running.

Always open the garage doors fully before starting the engine inside a garage to ensure adequate ventilation. The exhaust gases contain carbon monoxide, which is invisible and odorless but very poisonous.

CAUTION:

Never race the engine **immediately after starting**. Oil flow may not reach some lubricating points fast enough to prevent engine damage.

Do not race the engine just prior to switching off!

Hydraulic valve lifters

This engine features hydraulic valve lifters which means that valve clearance is adjusted automatically. It is possible that the valve lifters will produce a ticking sound for the first few seconds after the engine is started, while the oil pressure is increasing.

If the car has not been used for a long period of time, this ticking sound may last for up to 15 minutes. This is entirely normal.

Do not exceed 3000 rpm until the ticking sound disappears.



[Contents](#) | [Top of Page](#)

2000 VOLVO S & V70

pg. 72 Manual transmission

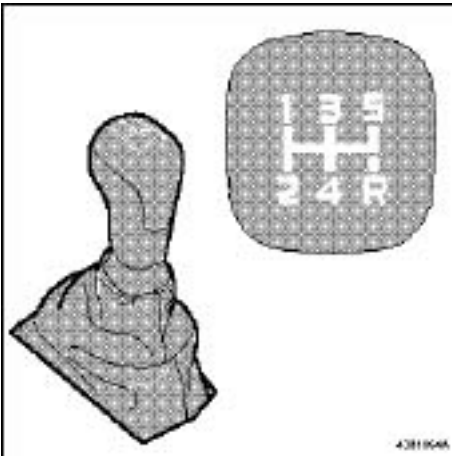

Shift positions

Depress the clutch pedal completely when changing gears*.

Remove your foot from the clutch pedal while driving.

Overdrive (5th gear) should be used as often as possible to help improve fuel economy. This gear can be engaged at speeds above approx. 50 mph (80 km/h).

CAUTION: Follow the shift pattern indicated on the gear shift knob when shifting up (e.g., do not shift directly from 2nd to 5th gear) to help avoid excessive wear on the transmission.

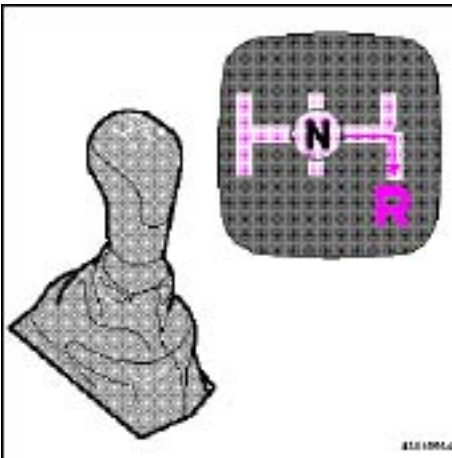

Engaging reverse gear

The gear lever must first be moved to neutral in order to engage reverse gear.

CAUTION: Be careful that you do not inadvertently engage reverse while moving forward.

* Clutch interlock (manual transmission only)

The clutch must be fully depressed before you can start your car. If the clutch is not depressed, it will not be possible to start the engine.

pg. 73 AW4 4-Speed Automatic Transmission (turbo models)

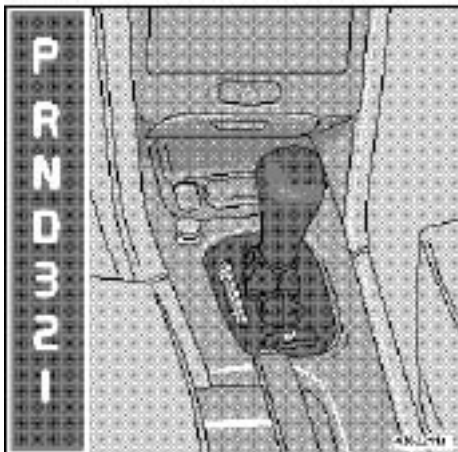

P (Park)

Use this position when starting the engine or parking the car.

Never use P while the car is in motion.

The parking brake should also be used when parking on grades.

The gear selector is mechanically locked in the P position (SHIFTLOCK). To release the gear selector from this position, the engine must be running (or the ignition key must be in position II) and the brake pedal must be depressed.

WARNING!

Never leave the car unattended when the engine is running. If, by mistake, the gear selector is moved from P, the car may start moving.

R (Reverse)

Never engage R while the car is moving forward.

N (Neutral)

Neutral - no gear engaged. Use the parking brake.

D (Drive)

D is the normal driving position and should be used as often as possible to help improve fuel economy. The car should not be moving when shifting from R to the D position.

3 (Intermediate gear)

The transmission will shift automatically between gears 3, 2 or 1 from this position. **The transmission cannot shift up to 4 (D) from position 3.** The indicator lamp  in the instrument panel lights up when this mode is selected.

2 (Intermediate gear)

The transmission will shift automatically between gears 2 and 1 from this position. **The transmission cannot shift up to 3 from position 2.** The indicator lamp  in the instrument panel lights up when this mode is selected.

1 (Low gear)

The transmission is locked in the lowest gear when the selector is in this position. The indicator lamp  in the instrument panel lights up when this mode is selected. If you are driving above 31 mph (50 km/h) when position 1 is selected, the transmission will automatically first shift to intermediate gear 2 until the speed has dropped to under 31 mph (50 km/h).

NOTE:

- Gears 3, 2, or 1 can be used if you are driving in a mountainous area, towing a trailer or to increase engine braking capacity.
- The transmission has a built-in function which is designed to help prevent excessive engine speeds (high rpm) when gears 3, 2 or 1 are selected.

Automatic transmission - adaptive system

The automatic transmission is controlled by an adaptive guidance system that constantly monitors the way in which the transmission functions. It senses and adapts each gear shift for optimal performance. The system also monitors your particular driving style and adapts gear shifting accordingly.

pg. 74 AW4 4-Speed Automatic Transmission (turbo models)

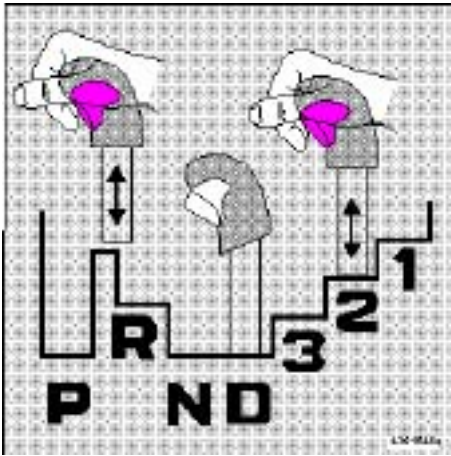

Automatic transmission - shift gate positions

The gear selector can be moved freely between N and D.

Depressing the selector knob enables you to move the gear selector to positions P, R, N, D, 3, 2 and 1.

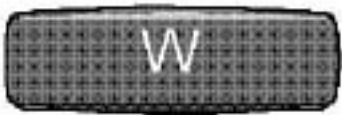

W Winter/Wet driving mode - enhanced vehicle traction

- Mode W will only function if the gear selector is in the (D)rive position.
- Press the button at the base of the gear selector to engage/disengage this driving mode (see illustration).
- An LED in the button will light up to indicate that **W** is engaged and this will also be displayed in the instrument panel by the indicator lamp  in the instrument panel.
- This mode may be selected for starting/moving off on slippery roads.

Kickdown

Automatic shift to a lower gear (kickdown) is achieved by depressing the accelerator pedal fully and briskly. An upshift will occur when approaching the top speed for a particular gear or by releasing the accelerator pedal slightly.

Kickdown can be used for maximum acceleration or when passing at highway speeds.

pg. 75 AW5 5-Speed Automatic Transmission (non-turbo models)

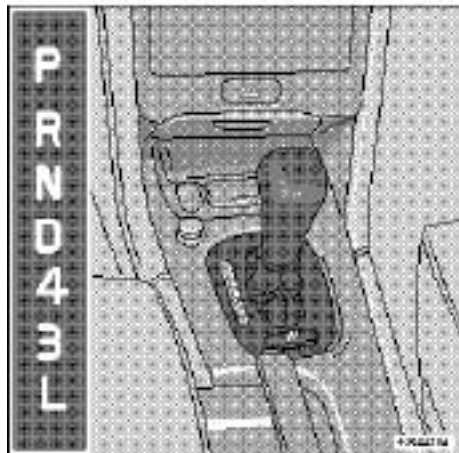

P (Park)

Use this position when starting the engine or parking the car.

Never use P while the car is in motion.

The parking brake should also be used when parking on grades.

The gear selector is mechanically locked in the P position (SHIFTLOCK). To release the gear selector from this position, the engine must be running (or the ignition key must be in position II) and the brake pedal must be depressed.

WARNING!

Never leave the car unattended when the engine is running. If, by mistake, the gear selector is moved from P, the car may start moving.

R (Reverse)

Never engage R while the car is moving forward.

N (Neutral)

Neutral - no gear engaged. Use the parking brake.

D (Drive)

D is the normal driving position and should be used as often as possible to help improve fuel economy. The car should not be moving when shifting from R to the D position.

4 (Intermediate gear)

The transmission will shift automatically between gears 4, 3, 2 or 1 from this position.

The indicator lamp  in the instrument panel lights up when this mode is selected.

The transmission cannot shift up to 4 (D) from position 3.

3 (Intermediate gear)

The transmission will shift automatically between gears 3, 2 and 1 from this position.

The indicator lamp  in the instrument panel lights up when this mode is selected.

The transmission cannot shift up to 3 from position 2.

L (Low gear)

The transmission is locked in gears 1 and 2 when the selector is in this position.

The indicator lamp  in the instrument panel lights up when this mode is selected.

NOTE:

- Gears 4, 3, or L can be used if you are driving in a mountainous area, towing a trailer or to increase engine braking capacity.
- The transmission has a built-in function which is designed to help prevent excessive engine speeds (high rpm) when gears 4, 3 or L are selected.

Automatic transmission - adaptive system

The automatic transmission is controlled by an adaptive guidance system that constantly monitors the way in which the transmission functions. It senses and adapts each gear shift for optimal performance. The system also monitors your particular driving style and adapts gear shifting accordingly.

pg. 76 AW5 5-Speed Automatic Transmission (non-turbo models)

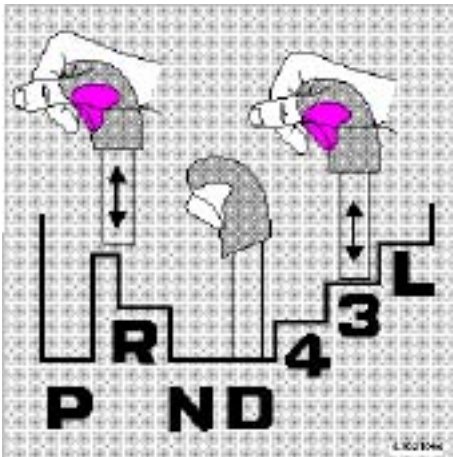

Automatic transmission - shift gate positions

The gear selector can be moved freely between N and D.

Depressing the selector knob enables you to move the gear selector to positions P, R, N, D, 4, 3 and L.

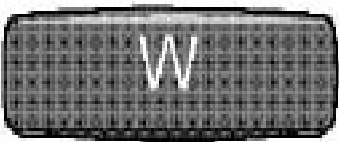

W Winter/Wet driving mode - enhanced vehicle traction

- Mode W will only function if the gear selector is in the (D)rive position.

- Press the button at the base of the gear selector to engage/disengage this driving mode (see illustration).
- An LED in the button will light up to indicate that **W** is engaged and this will also be displayed in the instrument panel by the indicator lamp .
- This mode may be selected for starting/moving off on slippery roads.

Kickdown

Automatic shift to a lower gear (kickdown) is achieved by depressing the accelerator pedal fully and briskly. An upshift will occur when approaching the top speed for a particular gear or by releasing the accelerator pedal slightly.

Kickdown can be used for maximum acceleration or when passing at highway speeds.

pg. 77 Automatic transmission, All Wheel Drive (AWD) (certain models)

Special tips automatic transmission

- For driving down steep hills and when driving for prolonged periods at low speeds, position L should be selected. Avoid, however, repeated changes since this can cause overheating of the transmission oil. For driving on long continuous uphill gradients, select position 4 or 3.
- Never select P or R while the car is in motion.
- When initially selecting positions D, 4, 3, 2, 1, L or R, your right foot should press firmly on the brake pedal to ensure that the car is standing still with the engine idling.
- The gear selector should not be downshifted to L at speeds above 75 mph (125 km/h). **Always observe posted speed limits.**
- Do not hold the car stationary on an incline by using the accelerator pedal. Instead, apply the hand brake (parking brake). This prevents the transmission oil from becoming overheated.
- When towing a trailer, select shift

position 4 or 3.

- While towing a trailer in hilly terrain, do not drive continuously at engine speeds above 4500 rpm to help avoid high engine oil temperatures.
- On certain models during cold starts, the transmission will shift up at higher rpm to enable the three-way catalytic converter to reach its normal operating temperature as quickly as possible.

All Wheel Drive (AWD) (certain models)

The All Wheel Drive system in your Volvo is designed to meet rigorous technical requirements. Used correctly, AWD better enables you to deal with varying road conditions than would be possible on a car equipped with conventional front or rear wheel drive only.

Please note that the AWD system is permanently engaged.

How your All Wheel Drive (AWD) system works

All Wheel Drive means that all four wheels on your vehicle are powered at the same time. The power is distributed automatically between the front and rear wheels. A viscous coupling distributes the power between the pair of wheels with the best traction in the current road conditions. This improves roadholding and helps avoid wheel-spin.

In normal conditions, the majority of the power is distributed to the front wheels. The front wheels are equipped with Volvo's anti-spin system TRACS, which is integrated with the car's ABS brake system. Power to the rear wheels is regulated by a differential lock if one of these wheels should lose traction when you start to drive off. The improved traction helps increase driving safety in the rain, snow and freezing road conditions.

A freewheel module disconnects the power to the rear wheels when the brakes are applied in order to give the car good braking stability.

WARNING!

Cars equipped with All Wheel Drive are not designed or intended for off-road driving.

pg. 78 Points to remember

Cooling system

The risk for engine overheating is greatest, especially in hot weather, when:

- Towing a trailer up steep inclines for prolonged periods at wide open throttle and low engine rpm.
- Stopping the engine suddenly after high speed driving (so-called "after-boiling" can occur).
- To avoid overheating, the following rules should be followed:

Do not drive for prolonged periods at engine speeds above 4500 rpm if you are towing a trailer in hilly terrain.

Reduce speed and downshift when towing a trailer up long, steep inclines. The risk of overheating can be reduced by switching off the air conditioning system for a short time.

Do not let the engine idle unnecessarily for prolonged periods.

Do not mount auxiliary lamps in front of the grill.

When the risk of overheating is imminent, or in the event of overheating (the temperature gauge goes

repeatedly into, or stays continually in, the red section), the following precautions should be taken:

- Switch off the air conditioning system.
- Pull off the road, away from traffic, stop the car and put the gear lever into neutral. **Do not stop the engine!**
- Switch the heater to full (maximum) position. Increase the engine speed to approx. 2000 rpm (twice idling speed) until the temperature begins to drop.

WARNING!

Do not remove coolant expansion tank cap. The coolant will be extremely hot.

See "Coolant" to check and top-up the coolant level if necessary.

CAUTION: Drive slowly and carefully if going through standing water (i.e. flooded roadways, etc.). Damage to engine could result if excess water is ingested through the air intake system.

Never drive the vehicle in water deeper than 1 foot (300 mm). See flood warning on page 7.

WARNING!

Do not drive with trunk lid open! A warning light in the instrument panel will indicate that the trunk is open. Poisonous exhaust gases may enter via the open trunk lid.

If the trunk lid/tailgate must be kept open for any reason, proceed as follows:

- Close the windows.
- Set the ventilation system control to air flow to floor, windshield and side windows and blower control to its highest setting.

Electrical system

When replacing the battery or when carrying out work involving the electrical system, the

following should be observed:

- A battery connection to the wrong terminal will damage the electrical system. Before connections are made, check the polarity of the battery with a voltmeter.
- If booster batteries are used for starting, they must be properly connected to minimize the risk of the electrical system being damaged. For correct connection, see "Jump starting" section.
- Never disconnect the battery circuit (for example, to replace the battery) while the engine is running or

the ignition is switched on, as this will immediately ruin the generator. Always make sure that all the battery connections are properly tightened.

- If any electrical welding work is performed on the vehicle, the battery's ground lead (negative cable) and all the connecting cables of the generator must be disconnected and the welder cables placed as near the welding points as possible.
- The radio must be turned off before the battery is disconnected.
- The anti-theft code must be re-entered before the radio will function properly.
- The electrical system in your car is designed to accommodate Volvo accessories. It also has an accessory connector located beneath the dashboard on the driver's side.

pg. 79 Points to remember

Weight distribution affects handling

At the specified curb weight your car has a tendency to understeer, which means that the

steering wheel has to be turned more than might seem appropriate for the curvature of a bend. This ensures good stability and reduces the risk of rear wheel skid. Remember that these properties can alter with the vehicle load. The heavier the load in the trunk (max. 220 lbs, 100 kg), the less the tendency to understeer.

Handling, roadholding

Vehicle load, tire design and inflation pressure all affect vehicle handling. Therefore, check that the tires are inflated to the recommended pressure according to the vehicle load. See "Tire pressure" section.

Loads should be distributed so that capacity weight or maximum permissible axle loads are not exceeded.

WARNING!

It is recommended that tires of the same make and dimensions be used on all four wheels (including the use of snow tires). Do not use bias ply tires as this will adversely alter vehicle handling characteristics. Maintain correct tire pressure.

Roof rails/racks

Roof racks are available as Volvo accessories. Observe the following points when in use:

- Avoid single-point loads. Distribute the load evenly.

Holes for roof rack

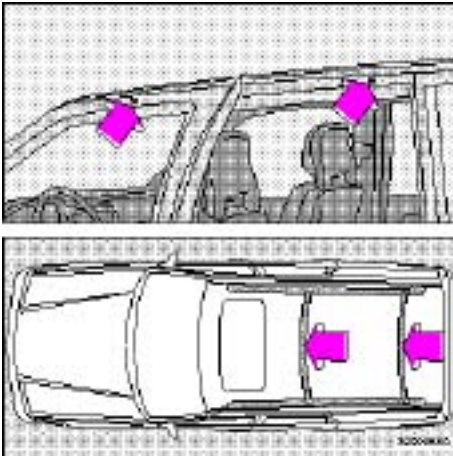

Wagon with roof rails (certain models)

- Place heavier cargo at the bottom of the load.
- Observe that the center of gravity and handling are influenced by load weight.
- Increasing load size increases wind resistance and thus adversely affects fuel economy.
- Anchor the cargo correctly with appropriate tie-down equipment.
- Drive carefully. Avoid rapid starts, fast cornering and hard braking.
- Max. roof load is 220 lbs (100 kg) when Volvo approved removable roof racks are attached to the points indicated in the illustration. For permanent roof racks, check the manufacturer's weight specifications.

· **Wagons equipped with roof rails (certain models):** The optional cross bars designed for use with roof rails are slightly curved. The curve should be toward the front of the car when the cross bars are used (see illustration). The cross bars are marked front/rear and left/right. The cross bars can be installed/removed by loosening/tightening the screws on the clamps at each end of the cross bar and sliding one end of the bar forward until it can be lifted on/off the rail. A special torx tool, inserted in the screw driver handle from the car's tool bag, is designed for this purpose and is included in the tool bag on these models.

CAUTION: The lugs on the lower cross bar mounting clamps must be properly seated in the groove on the underside of the roof rails when the clamps are tightened. Check and retighten the clamps at regular intervals.

If the cross bars are left on the car for extended periods but are not being used, slide them as far to the rear as possible to help minimize wind noise.

WARNING!

An extra mat on the driver's floor can cause the accelerator pedal to catch. Check that the movement of the accelerator pedal is not impeded. Not more than one protective floor covering may be used at one time.



[Contents](#) | [Top of Page](#)

2000 VOLVO S & V70

pg. 80 Emergency towing (pulling of vehicle)

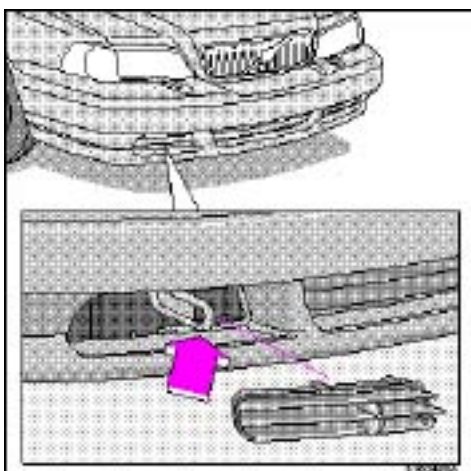

Front eyelet

Precautions when the car is in tow

- Steering must be unlocked.

Automatic transmissions only:

- Gear selector in position N. Check transmission oil level (see section titled "Transmission oil").
- Maximum speed: 20 mph (30 km/h).
- Maximum distance with front wheels on ground: 20 miles (30 km).
- If the battery is dead, it is not possible to release the gear selector by pressing the brake pedal. Release the gear selector manually, by pressing the **OVERRIDE** button near the base of the gear selector.

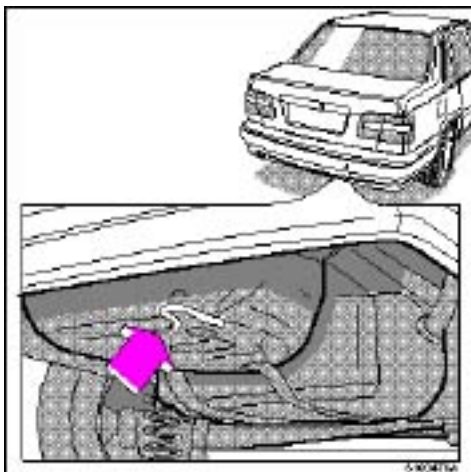

Rear eyelet

WARNING!

- Remember that the power brakes and power steering will not function when engine is not running. The braking system will function but the brake pedal pressure required is 3 - 4 times above normal and greater steering effort must be exerted.
- The towing eyelets must not be used for pulling another vehicle out of a ditch or for any similar purpose involving severe strain.
- Do not use the towing eyelets to pull the car up onto a flat bed tow truck.

CAUTION:

- Please check with state and local authorities before attempting this type of towing, as vehicles being towed are subject to regulations regarding maximum towing speed, length and type of towing device, lighting, etc.
- If the car's battery is dead, the engine must be jump started using an auxiliary battery (see page 80). Do not attempt to start the car by pushing or pulling it as this will damage the three-way catalytic converter (s).
- If the car is being towed on a flat bed truck, the towing eyelets must not be used to secure the car on the flat bed. Consult the tow truck operator.

pg. 81 Vehicle towing information

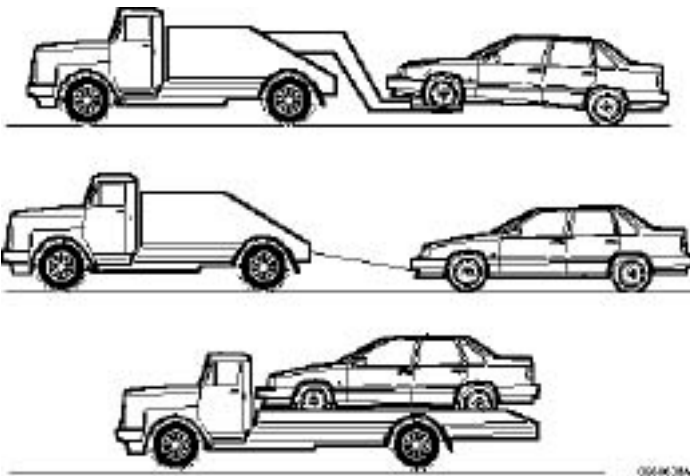

All Wheel Drive cars must not be towed with one of the axles raised or with the wheels on the ground. Only front wheel drive cars may be towed in either of these ways. Flat bed equipment is the only way to tow cars with All Wheel Drive and is recommended for cars with front wheel drive.

Towing cars with front wheel drive

Volvo recommends the use of flat bed equipment.

If wheel lift equipment must be used, please use extreme caution to help avoid damage to the car. **In this case, the car should be towed with the rear wheels on the ground if at all possible.**

If it is absolutely necessary to tow the vehicle with the front wheels on the ground, please refer to the towing information on the previous page.

CAUTION:

- Sling-type equipment applied at the front will damage radiator and air conditioning lines.
- It is equally important not to use sling-type equipment at the rear or apply lifting equipment inside the rear wheels; serious damage to the rear axle may result.
- If the car is being towed on a flat bed truck, the towing eyelets must not be used to secure the car on the flat bed. Consult the tow truck operator.

Cars with All Wheel Drive (AWD)

Cars equipped with All Wheel Drive must not be towed or transported with only one of the axles raised or with all four wheels on the ground (see illustrations above). Towing or transporting the car incorrectly will damage the viscous coupling which distributes power between the front and rear drive wheels.

Only use flat bed equipment.

WARNING!

Do not use the towing eyelets on the car to pull the car up onto a flat bed tow truck.

pg. 82 Jump starting

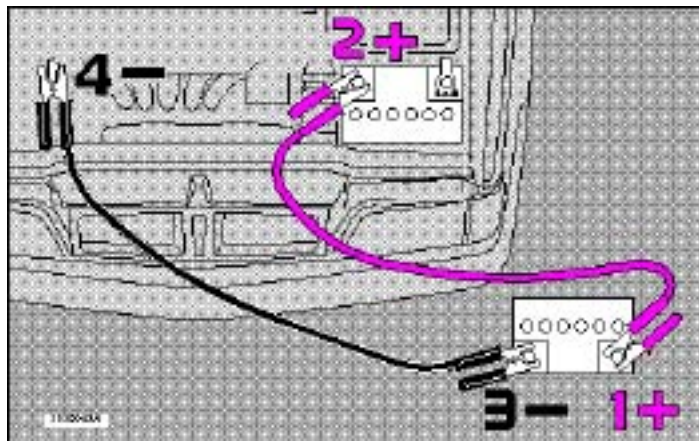

Jump starting

If the 12-volt booster battery to be used is in another car, check that the cars are not touching to prevent premature completion of a negative circuit. Note the position of the battery terminals and using jumper cables:

- First connect the booster battery positive (+) terminal (1) to car battery positive (+) terminal (2).
- Then connect the booster battery negative (-) terminal (3) to a stationary solid metal part on the engine at a point away from the battery (4).

Do not connect the jumper cable to any part of the fuel system or to any moving parts. Avoid touching hot manifolds.

After the engine has started, first remove the negative (-) terminal jumper cable. Then remove the positive (+) terminal jumper cable.

CAUTION: Improper hookup of jumper cables or use of other than 12-volt batteries could result in damage to equipment and/or the battery.

WARNING!

- Never expose the battery to open flame or electric spark.
- Do not smoke near the battery.
- Batteries generate hydrogen gas which is flammable and explosive.
- Battery fluid contains sulfuric acid. Do not allow battery fluid to contact eyes, skin, fabrics or painted surfaces. If contact occurs, flush the affected area immediately with water. Obtain medical help immediately if eyes are affected.

Failure to follow the instructions for jump starting can lead to personal injury.

NOTE: Refer to [page 132](#) for information on properly maintaining the battery.

Anti-lock Brake System (ABS)

If the warning lamp lights up there is a malfunction of the ABS system (the standard braking system will however function) and the vehicle should be driven cautiously to a Volvo retailer for inspection. The Anti-lock Braking System (ABS) helps to improve vehicle control (stopping and steering) during severe braking conditions by limiting brake lock-up. When the system "senses" impending lock-up, braking pressure is automatically modulated in order to help prevent lock-up, which could lead to a skid.

The system performs a self-diagnostic test when the vehicle first reaches a speed of approximately 12 mph (20 km/h). The brake pedal will pulsate several times and a sound may be audible from the ABS control module. This is normal.

To obtain optimal effect from the ABS system, constant pressure should be kept on the brake pedal while the system is modulating the brakes. Do not pump the brake pedal.

The switching of the ABS modulator will be audible and the brake pedal will pulsate at this time. Please be aware that ABS does not increase the absolute braking potential of the vehicle. While control will be enhanced, ABS will not shorten stopping distances on slippery surfaces.

Brake circuit malfunction

If one of the brake circuits should malfunction, the red warning light will come on, the pedal stroke increases slightly, the pedal feels softer and extra pressure is required for normal braking. If the light comes on while driving or braking, stop immediately and check the brake fluid level in the reservoir.

WARNING!

If the fluid level is below the MIN mark in either section of the reservoir: **DO NOT DRIVE.** Tow the car to a Volvo retailer and have the brake system checked and any leakage repaired.

Moisture on brake discs and brake pads affects braking

Driving in rain and slush or passing through an automatic car wash can cause water to collect on the brake discs and pads. This will cause a delay in braking effect when the pedal is depressed. To avoid such a delay when the brakes are needed, depress the pedal occasionally when driving through rain, slush etc. This will remove the water from the brakes. Check that brake application feels normal. This should also be done after washing or starting in very damp or cold weather.

Severe strain on the brake system

The brakes will be subject to severe strain when driving in mountains or hilly areas or towing. The speed is usually low which means that the cooling of the brakes is less efficient than when driving on level roads. To reduce the strain on the brakes, it is advisable not to use the brakes excessively. Instead, shift into a lower gear, position 3 or in some cases, L (automatic transmission) and let the engine help with the braking. Do not forget that, if you are towing a trailer, the brakes will be subjected to greater load than is normal.

If the brake power-assist does not function

The power assist to the brakes functions only when the engine is running. When the car is moving without the engine running, the brake pedal pressure required to stop the car is increased by 34 times and the brake pedal feels stiff.

pg. 84 Brake system (EBD), TRACS, STC

EBD (Electronic Brake-force Distribution)

EBD is an integrated part of the ABS system. EBD regulates the hydraulic pressure to the rear brakes to help provide optimal braking capacity.

If the **BRAKE** and **ABS** warning lights come on at the same time, this could indicate a fault in the brake system. If the brake fluid level is above the MIN mark, drive carefully to an authorized Volvo retailer and have the brake system inspected.

WARNING!

If the fluid level is below the MIN mark in the reservoir, **DO NOT DRIVE**. Have the car towed to an authorized Volvo retailer and have the brake system inspected.

TRAction Control System (TRACS) - option on certain models

TRACS is a system designed as an aid when starting/driving off if one of the drive wheels has poor traction due to weather conditions or the road surface and is connected to the ABS control module.

TRACS engages automatically at speeds below 25 mph (40 km/h) when one of the drive wheels loses traction. It disengages automatically when speed exceeds 25 mph (40 km/h). The sound which can be heard when the system is operating comes from the ABS system.

TRACS can be disengaged manually using the switch on the dashboard (see [page 27](#)). The indicator light will come ON when the system is off.

Stability and Traction Control (STC) - option on certain models

Stability Traction Control works in conjunction with TRACS to help control wheel spin at all speeds. At speeds below 25 mph, TRACS controls the braking system to stop wheel spin. At speeds over 25 mph (40km/h), the STC system monitors and compares all four wheels. If one of the drive (front) wheels shows any tendency to slip, such as when driving on slippery roads, the difference in speed is immediately detected. This triggers a signal to the engine management system, which will reduce engine torque (by reducing fuel) until the differential is corrected. This torque reduction is handled in stages, and reaction time is extremely fast.

The symbol will **flash** when STC is actively regulating power to the drive wheels. Normal power may be reduced at this time. This is normal as power is momentarily reduced to help keep the drive wheels from losing traction and spinning.

The STC indicator light will come on:

- When the car is started, for approximately **2 seconds**, as the system performs a self-diagnostic test.
- When STC has been switched off using the button on the dashboard.
- If the system is temporarily switched off due to high brake temperatures. STC will automatically restart when brake temperature has returned to normal.
- If a fault is detected in the system. Consult your Volvo retailer if this occurs.

pg. 85 Winter driving

Cold weather precautions

If you wish to check your car before the approach of cold weather, the following advice is worth noting:

- Make sure that the **engine coolant** contains at least 50 percent antifreeze: that is, 3.7 qts. (3.5 liters) Volvo Genuine Coolant/Antifreeze. This gives protection against freezing down to -31°F (-35°C). See section "Coolant". **The use of "recycled" antifreeze is not approved by Volvo. Different types of antifreeze may not be mixed.**
- Try to keep the **fuel tank** well filled - this prevents the formation of condensation in the tank. In addition, in extremely cold weather conditions it is worthwhile to add fuel line de-icer before refueling.
- The viscosity of the engine oil is important. Oil with low viscosity (thinner oil) improves cold-weather starting as well as decreasing fuel consumption while the engine is warming up. For winter use, 5W-30 oil, particularly the synthetic type *, is recommended. Be sure to use good quality oil but do not use this cold-weather oil for hard driving or in warm weather. **See section "Engine oil" for more information.**
- The load placed on **the battery** is greater during the winter since the windshield wipers, lighting, etc. are used more often. Moreover, the capacity of the battery decreases as the temperature drops. In very

cold weather, a poorly charged battery can freeze and be damaged. It is therefore advisable to check the state of charge more frequently and spray an anti-rust oil on the battery posts.

- Volvo recommends the use of snow tires on all four wheels for winter driving - see section "Wheels and tires".

- To prevent the **washer fluid reservoir** from freezing, add washer solvents containing antifreeze (see page 131 for the location of the washer fluid reservoir). This is important since dirt is often splashed on the windshield during winter driving, requiring the frequent use of the washers and wipers. The Volvo Washer Solvent should be diluted as follows:

Down to 14° F (-10° C): 1 part washer solvent and 4 parts water

Down to 5° F (-15° C): 1 part washer solvent and 3 parts water

Down to 0° F (-18° C): 1 part washer solvent and 2 parts water

Down to -18° F (-28° C): 1 part washer solvent and 1 part water

- When driving in temperatures below 15° F (-10° C), we recommend the use of Volvo's radiator guard to help the engine reach normal operating temperature as quickly as possible. This guard should not be used when towing a trailer.

- Use Volvo Teflon Lock Spray in the locks.

NOTE: Avoid the use of de-icing sprays as they can cause damage to the locks.

* Synthetic oil is not used when the oil is changed at the normal maintenance service intervals.

pg. 86 Trailer towing

When preparing for trailer towing, observe the following:

- Volvo recommends the use of Volvo trailer hitches which are specially designed for the car. For trailer weights exceeding 2000 lbs (908 kg), use only a trailer hitch offered as a Genuine Volvo Accessory.

NOTE: Models with automatic transmission are equipped with a transmission oil cooler as standard equipment. This cooler helps prevent overheating of the transmission during times of increased load, as when towing a trailer.

Maximum trailer weight recommended by Volvo is:

- **Trailers without brakes:** 1100 lbs (500 kg)

- **Trailers with brakes:** 2" (50 mm) ball - 3300 lbs (1,500 kg), 1 7/8" (47 mm) ball - 2000 lbs (908 kg).

Observe the legal requirements of the state/province in which the vehicles are registered.

All Volvo models are equipped with energy-absorbing shock-mounted bumpers. Trailer hitch installation should not interfere with the proper operation of this bumper system.

Trailer towing does not normally present any particular problems, but take into consideration:

- Increase tire pressure to recommended full. See section "Wheels and tires".
- Recommended hitch tongue load is 110 lbs (50 kg) for trailer weights below 2,650 lbs (1,200 kg) and 165 lbs (75 kg) for trailer weights above 2,650 lbs (1,200 kg). For trailer weights between 2,650 - 3,300 lbs (1,200 - 1,500 kg) a top speed of 50 mph (80 km/h) should never be exceeded.
- Engine and transmission are subject to increased loads. Therefore, engine coolant temperature should be closely watched when driving in hot climates or hilly terrain. Use a lower gear and turn off the air conditioner if the temperature gauge pointer enters the red range.
- Avoid overload and other abusive operation.
- Hauling a trailer affects handling, durability, and economy.
- It is necessary to balance trailer brakes with the towing vehicle brakes to provide a safe stop (check and observe State/Local regulations).
- Do not connect the trailer's brake system directly to the vehicle's brake system.
- More frequent vehicle maintenance is required.
- Remove the ball and drawbar assembly when the hitch is not being used.
- Volvo recommends the use of synthetic engine oil when towing a trailer over long distances or in mountainous areas.

NOTE: Refer to section "Automatic transmission" for additional trailer hauling tips.

WARNING!

- Bumperattached trailer hitches must not be used on Volvos, nor should safety chains be attached to the bumper.
- Trailer hitches attaching to the vehicle rear axle must not be used.
- Never connect a trailer's hydraulic brake system directly to the vehicle brake system, nor a trailer's lighting system directly to the vehicle lighting system. Consult your nearest authorized Volvo retailer for correct installation.
- When towing a trailer, the trailer's safety wire must be correctly fastened to the hole or hook provided in the trailer hitch on the car. The safety wire should never be fastened to or wound around the drawbar ball.



[Contents](#) | [Top of Page](#)

2000 VOLVO S & V70

Chapter 5 - Wheels and tires

pg. 87 Wheels and tires

The handling and riding comfort of the vehicle is dependent on the inflation pressure and the type of tires fitted. Read the following pages carefully.

General information, Wear indicator, Tire economy, Flat spots	88
Snow chains, Winter tires	89
Inflation pressure	90
Uniform tire quality grading	91

pg. 88 Wheels and tires

General information

Your vehicle is equipped with tires according to the tire information label located on the rear facing side of the right front door.

The following is an **example** of a tire designation code 195/60R15:

195 = tire width in mm.

60 = tire profile. This is the relationship (in percent) between the section height and width of the tire.

R = radial tires.

15 = diameter in inches.

The tires have good road holding characteristics and offer good handling on dry and wet surfaces. It should be noted however that the tires have been developed to give these features on snow/icefree surfaces. **Certain models are equipped with "all-season" tires, which provide a somewhat higher degree of road holding on slippery surfaces than tires without the "all-season" rating.** However, for optimum road holding on icy or snow covered roads **we recommend suitable winter tires on all four wheels.** When replacing tires, be sure that the new tires are the same size designation, type (radial) and preferably from the same manufacturer, on all four wheels. Otherwise there is a risk of altering the car's roadholding and handling characteristics.

NOTE: When storing wheel/tire assemblies (e.g. winter tires and wheels), either stand the assemblies upright, or suspend them off the ground. Laying wheel/tire assemblies on their sides for prolonged periods can cause wheel and/or tire damage.

Wear indicator

The tires have a so-called "wear indicator" in the form of a number of narrow strips running across or parallel to the tread. When approx. 1/16" (1.6 mm) is left on the tread, these strips become visible and indicate that the tire should be replaced.

Tires with less than 1/16" (1.6 mm) tread have a very poor grip in rain or snow.

When replacing worn tires, it is recommended that the tire be identical in type (radial) and size as the one being replaced. Using a tire of the same make (manufacturer) will prevent alteration of the driving characteristics of the vehicle.

To improve tire economy:

- Maintain correct tire pressure. See the tire pressure label on the inside of the fuel tank cover.
- Drive smoothly: avoid fast starts, hard braking and tire screeching.
- Tire wear increases with speed.
- Correct front wheel alignment is very important.
- Unbalanced wheels impair tire economy and driving comfort.
- If the wheels are rotated, they should be kept on the same side of the car so that they revolve in the same direction as prior to rotation.
- Hitting curbs or potholes can damage the tires and/or wheels permanently.

Flat spots

All tires become warm during use. After cooling, when the vehicle is parked, the tires have a tendency to distort slightly, forming flat spots. These flat spots can cause vibrations similar to the vibrations caused by unbalanced wheels. They do, however, disappear when the tire warms up. The degree to which flat spots form depends on the type of cord used in the tire. Remember that, in cold weather, it takes longer

for the tire to warm up and consequently longer for the flat spot to disappear.

CAUTION: The car must not be driven with wheels of different dimensions or with a spare tire other than the one that came with the car. The use of different size wheels can seriously damage your car's transmission *.

* **This also applies to models equipped with All Wheel Drive (AWD)**

pg. 89 Wheels and tires

Snow chains

Snow chains can be used on your Volvo with the following restrictions:

- Snow chains should be installed on front wheels only (**this applies to cars with front wheel drive and to cars equipped with All Wheel Drive**). Use only Volvo approved snow chains.
- Snow chains can be mounted on the following tire dimensions:

Front wheel drive: 185/65 R15 and 195/60 R15. Tire dimension

205/55 R15 and 205/50 R16 require a special type of snow chain. Chains cannot be used on front wheel drive models equipped with 205/55 R16 tires.

All Wheel Drive: Special snow chains are available for AWD models equipped with 195/65 R15 and 205/55 R16 tires.

Chains cannot be used on V 70 XC AWD models equipped with 205/65 R15 tires. Consult your Volvo retailer.

If accessory, aftermarket or "custom" tires and wheels are installed and are of a size different than the original tires and wheels, chains in some cases CANNOT be used. Sufficient clearances between chains and brakes, suspension and body components must be maintained.

- Some strapon type chains will interfere with brake components and therefore CANNOT be used.

Consult your Volvo retailer for additional snow chain information.

CAUTION:

- Check local regulations regarding the use of snow chains before installing.
- Always follow the chain manufacturer's installation instructions carefully. Install chains as tightly as possible and retighten periodically.

- Never exceed the chain manufacturer's specified maximum speed limit. (Under no circumstances should that limit be higher than 30 mph (45 km/h).
- Avoid bumps, holes or sharp turns when driving with snow chains.
- The handling of the vehicle can be adversely affected when driving with chains. Avoid fast or sharp turns as well as locked wheel braking.

Snow tires, studded tires *

Tires for winter use:

Owners who live in or regularly commute through areas with sustained periods of snow or icy driving conditions are strongly advised to fit suitable winter tires to help retain the highest degree of traction.

It is important to install winter tires **on all four wheels** to help retain traction during cornering, braking, and accelerating. Failure to do so could reduce traction to an unsafe level or adversely affect handling. Do not mix tires of different design as this could also negatively affect overall tire road grip. **Volvo recommends 185/65 R15 winter tires on 15" wheels on all front wheel drive S/V 70 models** including models equipped with 16" or 17" wheels.**

Winter tires wear more quickly on dry roads in warm weather. They should be removed when the winter driving season has ended.

Studded tires should be run in 300600 miles (5001000 km) during which the car should be driven as smoothly as possible to give the studs the opportunity to seat properly in the tires. The car tires should have the same rotational direction throughout their entire lifetime. In other words, if you wish to rotate the wheels, make sure that the same wheels are always on the same side of the car.

NOTE: Please consult state or provincial regulations restricting the use of studded winter tires before installing such tires.

* Where permitted.

** All Wheel Drive models, including the AWD XC should be equipped with 195/65 R15 winter tires.

pg. 90 Wheels and tires

Checking and correcting tire pressure

- Check the tire pressure when refuelling.
- The tire pressure should be corrected only when the tires are cold.

- With warm tires, correct only when the pressure is too low. The tire temperature rises after driving just a few miles.

Vehicle loading

The tires on your Volvo will perform to specifications at all normal loads when inflated as recommended on the tire information label* located on the inside of the fuel filler flap. This label lists both tire and vehicle design limits.

Do not load your car beyond the load limits indicated.

*Please note that the tire information label indicates pressure for both comfort and fuel economy.

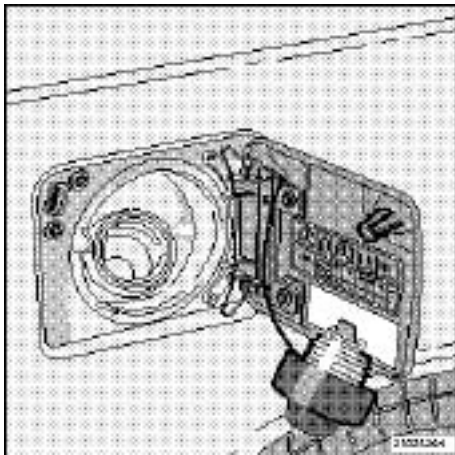

Tire pressure label

pg. 91 Wheels and tires

Uniform tire quality grading

All passenger car tires must conform to Federal Safety Requirements in addition to these grades

TREADWEAR

The treadwear grade is a comparative rating based on the wear rate of the tire when tested under controlled conditions on a specified government test course. For example, a tire graded 150 would wear one and one half (1 1/2) times as well on the government course as a tire graded 100. The relative performance of tires depends upon the actual conditions of their use, however, and many depart significantly from the norm due to variation in driving habits, service practices and differences in road characteristics and climate.

TRACTION

The traction grades, from highest to lowest, are AA, A, B, and C, as measured under controlled conditions on specified government test surfaces of asphalt and concrete. A tire marked C may have poor traction performance.

WARNING!

The traction grade assigned to this tire is based on braking (straight-ahead) traction tests and does not include cornering (turning) traction.

TEMPERATURE

The temperature grades are AA (the highest), A, B, and C, representing the tire's resistance to the generation of heat and its ability to dissipate heat when tested under controlled conditions on a specified indoor laboratory test wheel. Sustained high temperature can cause the material of the tire to degenerate and reduce tire life, and excessive temperature can lead to sudden tire failure. The grade C corresponds to a level of performance which all passenger car tires must meet under the Federal Motor Safety Standard No. 109. Grades B and A represent higher levels of performance on the laboratory test wheel than the minimum required by law.

WARNING!

The temperature grade for this tire is established for a tire that is properly inflated and not overloaded. Excessive speed, underinflation, or excessive loading, either separately or in combination, can cause heat buildup and possible tire failure.



2000 VOLVO S & V70

Chapter 6 - In case of an emergency

pg. 93 In case of an emergency

Even if you maintain your car in good running condition, there is always the possibility that something might go wrong and prevent you from driving, such as a punctured tire, blown fuse or bulb, etc. For additional information, see section "ON CALL Road Assistance".

Wheel changing	94-95
Spare tire	96
Replacing bulbs	97-103
Replacing fuses	104-106
Installation of accessories	107
Replacing wiper blades	108-109
In case of emergency	110

pg. 94 Wheel changing

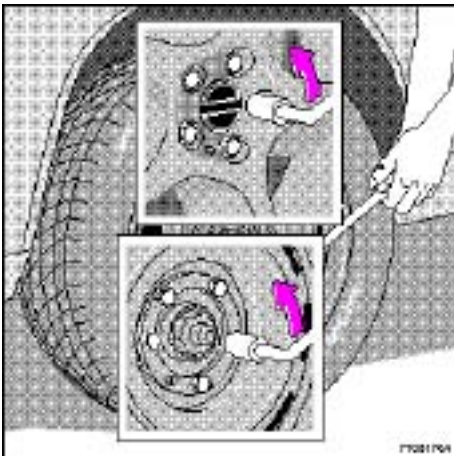

Loosen wheel bolts

Changing a wheel

The spare wheel is located under the carpet on the trunk floor. The jack and crank are secured in the wheel recess.

- Engage the parking brake.
- Put the gear selector in (P)ark (automatic) or in Reverse (manual).
- Remove the wheel cap (where applicable) using the lug wrench in the tool kit.
- With the car still on the ground, use the lug wrench to loosen the wheel bolts 1/2 1 turn. Turn the bolts counterclockwise to loosen.

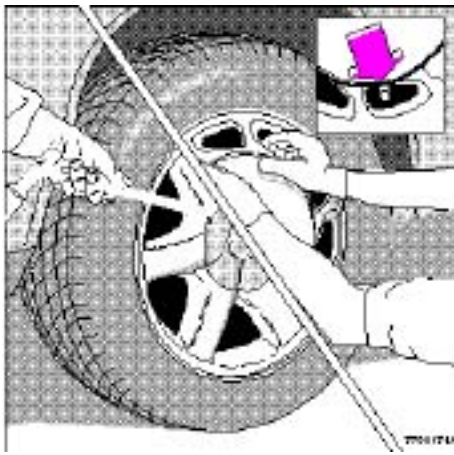

*Insert flat end of lug wrench and turn/
Pull straight out*

- Fold out the crank handle on the jack by pressing the knob on the handle downward. To attach the jack, refer to the illustration on the following page.

NOTE: To avoid excessive wear and the necessity of rebalancing, mark and reinstall wheels in the same location and position as before removal. To lessen the chance of imbalance, each wheel hub is equipped with a guide stud to ensure that a removed wheel can be reinstalled in its original position (as when changing over to winter tires/wheels).

CAUTION:

- The car must not be driven with wheels of different dimensions or with a spare tire other than the one that came with the car. The use of different size wheels can seriously damage your car's transmission.
- Correct tightening torque on wheel bolts must be observed. The wheel bolts should never be greased or lubricated. The extended, chromed wheel bolts must not be used with steel rims, as they make it impossible to fit the hub caps.

WARNING!

- The jack (see the following page) must correctly engage the bar in the jack attachment (A). The car's weight must not rest on the jack attachment (B).
- Be sure the jack is on a firm, level, non-slippery surface.
- Never allow any part of your body to be extended under a car supported by a jack.
- Use the jack intended for the car when replacing a wheel. For any other job, use stands to support the side of the car being worked on. -
- Apply the parking brake, select position P (automatic transmission) or Reverse gear (manual transmission).
- Block the wheels standing on the ground, use rigid wooden blocks or large stones.
- The jack should be kept well-greased.

pg. 95 Wheel changing

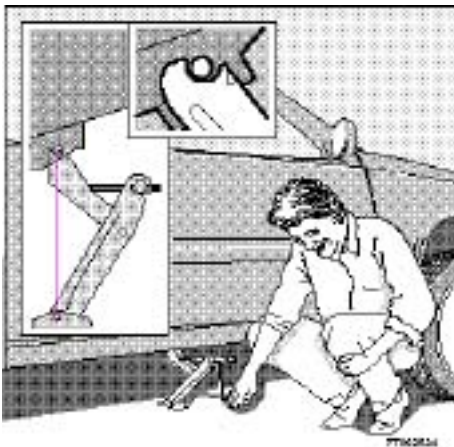

Jack attachment - front wheel drive models

Attaching the jack

There is a jack attachment located in the center on each side of the car. Position the jack on the bar in the attachment and crank while simultaneously guiding the base of the jack to the ground. **The base of the jack must be flat on a level, firm, non-slippery surface. Before raising the car, check that the jack is still correctly positioned in the attachment.** Raise the vehicle until both wheels on the side of the car

where the jack is attached are lifted off the ground. Unscrew the wheel bolts completely and carefully remove the wheel so as not to damage the thread on the studs.

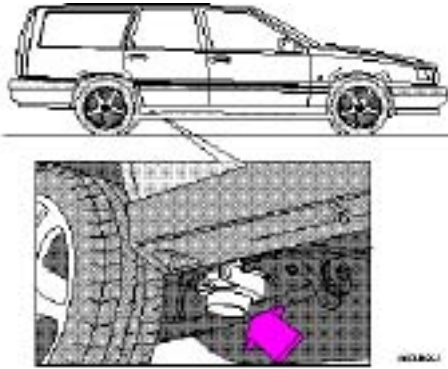

Additional rear jack attachment on All Wheel Drive cars

Attaching the jack on cars with All Wheel Drive (AWD)

Due to the greater weight of AWD-equipped cars, these models have an additional jack attachment point located directly in front of the rear axle. When using a workshop floor jack, make sure that the correct attachment is used and that the jack does not damage the fuel tank.

The attachment is, of course, also intended for use with the standard jack supplied with the car.

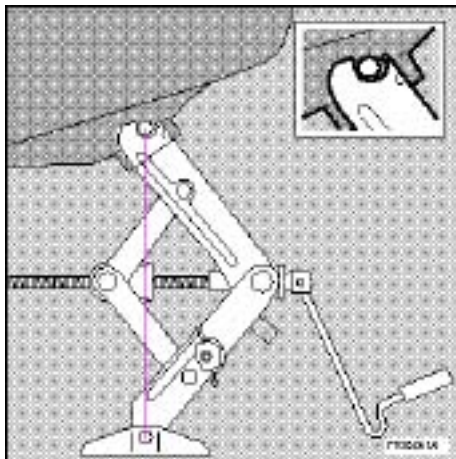

Proper jack attachment on AWD cars

Installing the wheel

Clean the contact surfaces on the wheel and hub. Lift the wheel and place it on the hub. Make sure that you align the wheel with the guide stud on the wheel hub prior to installation. Install the wheel bolts crosswise (see illustration) and tighten by turning lightly clockwise. Lower the vehicle to the ground and alternately tighten the bolts to 100 ft. lbs. (130 Nm). Install the wheel cap (where applicable).



Correct tightening order for wheel bolts

pg. 96 Spare tire

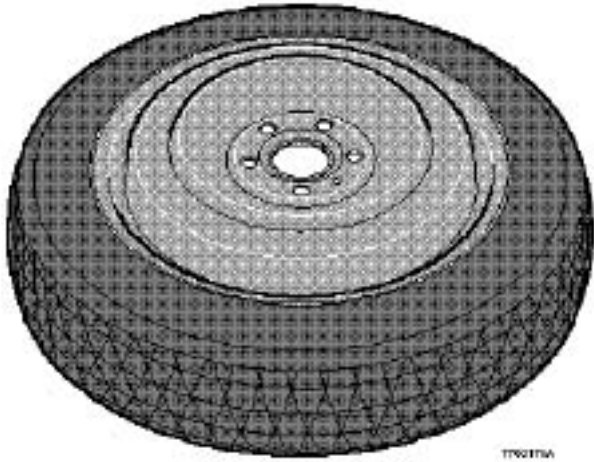

Temporary Spare (certain models)

The spare tire in your car is called a "Temporary Spare". It has the following designation: T115/70 R15 or T125/80 R17.

Recommended tire pressure (see decal on fuel filler flap) should be maintained irrespective of which position on the car the Temporary Spare tire is used on.

In the event of damage to this tire, a new one can be purchased from your Volvo retailer.

CAUTION: The car must not be driven with wheels of different dimensions or with a spare tire other than the one that came with the car. The use of different size wheels can seriously damage your car's transmission.

WARNING!

Current legislation prohibits the use of the "Temporary Spare" tire other than as a temporary replacement for a punctured tire. In other words, it must be replaced as soon as possible by a standard tire. Roadholding, etc., may be affected with the "Temporary Spare" in use. Do not, therefore, exceed 50 mph (80 km/h).

NOTE: Certain models are equipped with a full-size spare wheel.

pg. 97 Replacing bulbs

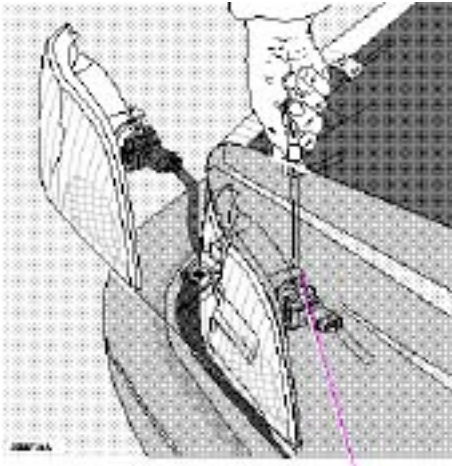

catch

Parking light/direction indicator

1. From the front of the car, use a screwdriver to press down on the silver catch (located in the space between the inside of the fender and the headlight unit) to release the lamp housing from the front fender.
2. Turn the bulb holder 1/4 turn clockwise (viewed from the front) and withdraw it from the front of the lamp housing. Leave the connector with its wires in the bulb holder.
4. Remove the bulb from the holder by pulling it straight out.

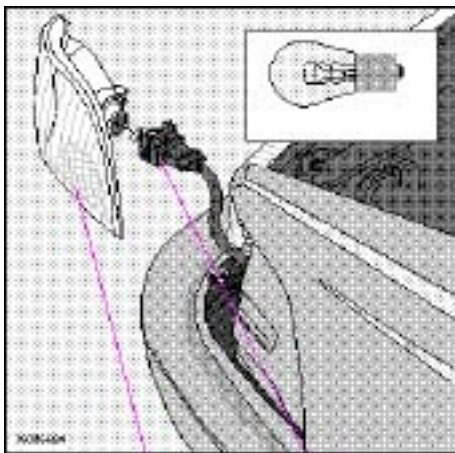

Lamp housing Bulb holder,br> Bulb- 3357NA, 26/7W/30/2.2cp

5. Press a new bulb into the holder and reinstall the unit in the reverse order.

Bulb holder

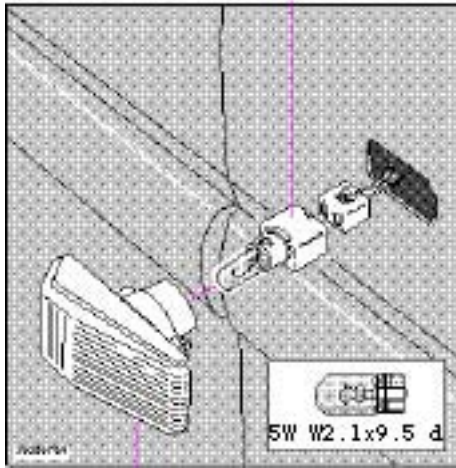

Side direction indicator

1. Slide the lens forward and pull out the rear edge.
2. Pull out the entire lens/bulb unit.
3. With the lens toward you, turn the bulb holder 1/4 turn (the wires should not be disconnected from the holder) and pull out the bulb holder from the lens unit.
4. Pull the old bulb straight out and press a new one into place.
5. Replace the entire unit in the reverse order.

pg. 98 Replacing bulbs

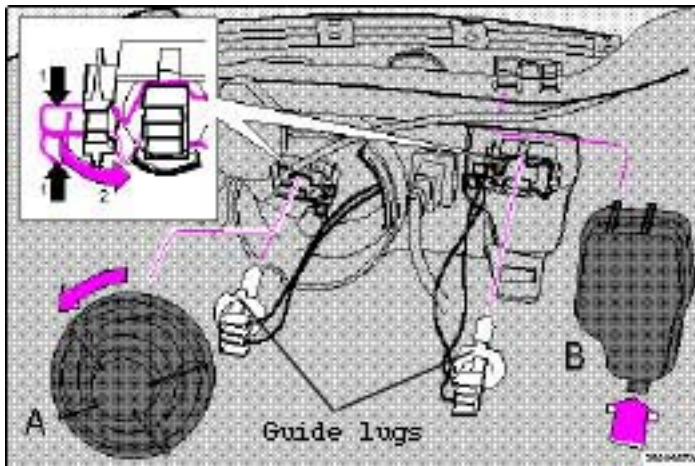

Bulbs (high and low beams) - H7

A - Low beam B - High beam

Low beam headlight bulb (A) replacement

1. Turn the plastic cover counterclockwise and remove it.
2. Press the wire catches on the retaining clamp (1 in inset illustration above) together and push out (2) to release the bulb and connector from the headlight housing.
3. Pull the bulb out of the connector.
4. Insert a new bulb into the connector.
5. Reinsert the bulb and connector into the headlight housing. The guide lug must be *up* to ensure proper positioning.
6. Press the retaining clamp back into position.
7. Reinstall the plastic cover.

Headlight adjustment

The height of the headlight beams can be adjusted according to vehicle load. The headlights should be readjusted if heavy loads are carried in the trunk/cargo area or rear seat, or when towing a trailer.

To adjust the headlights:

- Park the car on a level surface and open the hood.
- The headlights are equipped with a level which can be seen by looking through the clear "window" on the top of the headlight lens.
- Turn the height adjustment knob until the bubble in the level aligns with the "0" marks or within the dark marking lines.

Lateral headlight adjustment should only be carried out by an authorized Volvo retailer. The lateral adjustment scale should be preset at "0".

High beam headlight bulb (B) replacement

1. Pull the catch on the lower edge of the cover upward and remove the plastic cover.
2. Press the wire catches on the retaining clamp (1 in inset illustration above) together and push out (2) to release the bulb and connector from the headlight housing.
3. Pull the bulb out of the connector.

4. Insert a new bulb into the connector.
5. Reinsert the bulb and connector into the headlight housing. The guide lug must be *up* to ensure proper positioning.
6. Press the retaining clamp back into position.
7. Reinstall the plastic cover. Catch B should snap into position.

pg. 99 Replacing bulbs

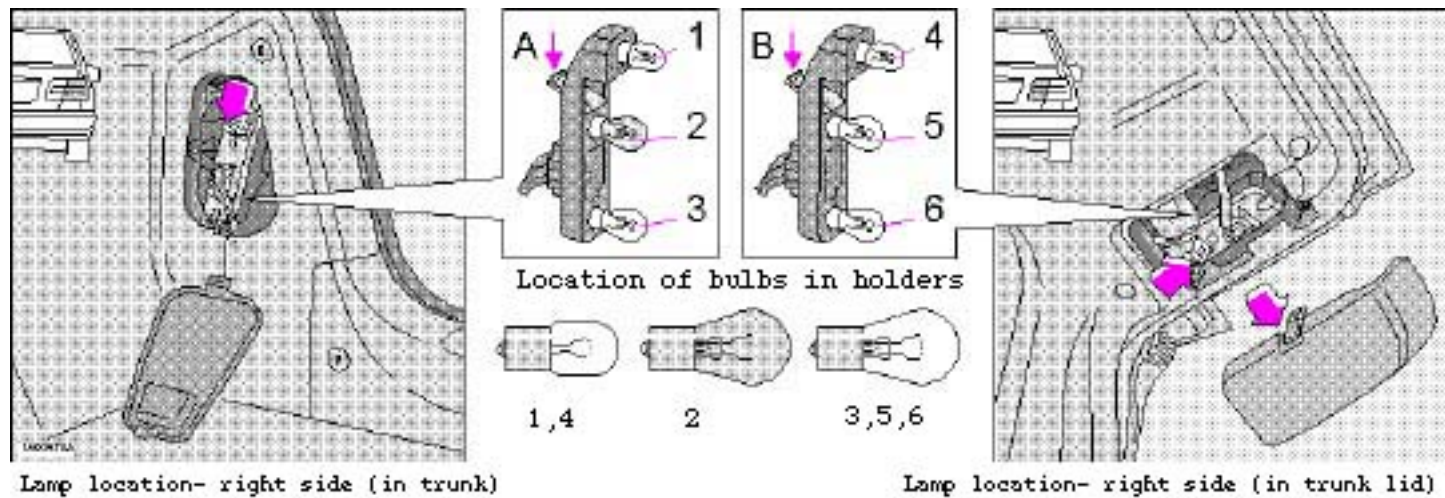

Tail light bulbs (sedans)

1. Tail light
2. Direction indicator
3. Brake light
4. Tail light
5. Backup light
6. Rear fog light (left side only)

All the bulbs in the tail light unit are replaced from inside the trunk as follows:

1. Turn the two plastic screws and open the cover over the rear lamp unit in the trunk (or depress the catch on the cover on the trunk lid) .
2. Press catch A or B and remove the bulb holder.
3. Let the connector with its wires remain attached to the bulb holder.
4. Remove the bulb by pressing in and turning counterclockwise.
5. Insert a new bulb into the holder and reinstall the holder into the tail light assembly.
6. Close the cover.

Bulbs 1,4:

5W/4 cp BA 15 s

Bulb 2:

21W BAU 15 s (amber)

Bulbs 3,5,6:

21W/32 cp BA 15 s

pg. 100 Replacing bulbs

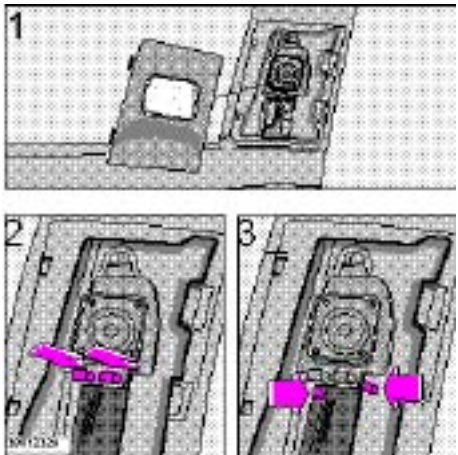

Removing speaker from upper section

Tail light bulbs (wagons)

- 1. Direction indicator
- 2. Brake light
- 3. Tail light
- 4. Back-up light
- 5. Tail light / Rear fog light (left side only)

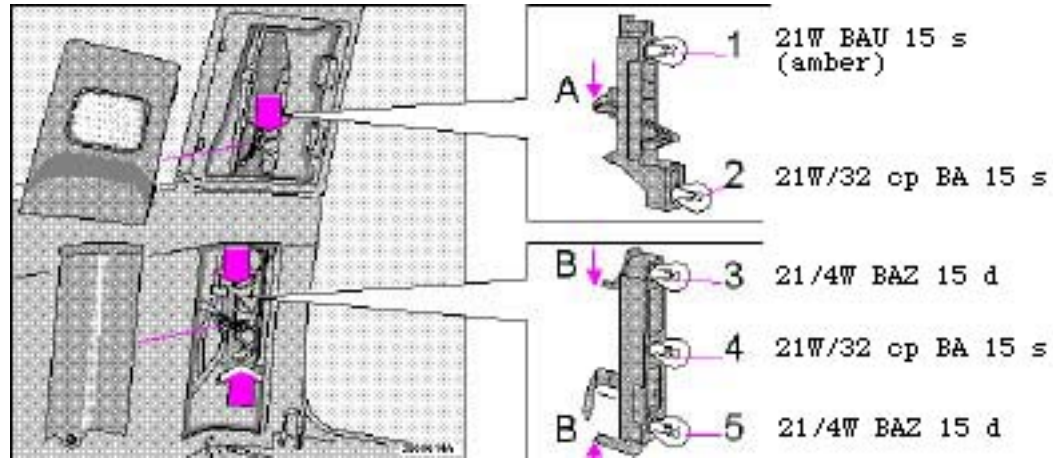

All the bulbs in the tail light unit are replaced from inside the cargo space as follows:

- Turn the ignition key to position 0 and switch off the lights.
- Remove the upper panel of the tail light unit by using a screwdriver (1) and/or the lower panel by first removing the side floor cover and turning the plastic screw at the bottom of the panel to release it.
- Press down catch A (upper section) * or press catches B toward each other (lower section) and take out the bulb holder.
- Leave the connector and cables connected to the bulb holder.
- Remove the bulb by pressing it inwards and turning it slightly counter-clocKwise.
- Insert a new bulb into the bulb holder and reinstall the holder in the tail light assembly.
- Check that the bulb works. Reinstall the cover.

* The optional speaker (see illustrations 2, 3)) must be removed first to gain access to the upper bulb holder.

pg. 101 Replacing bulbs

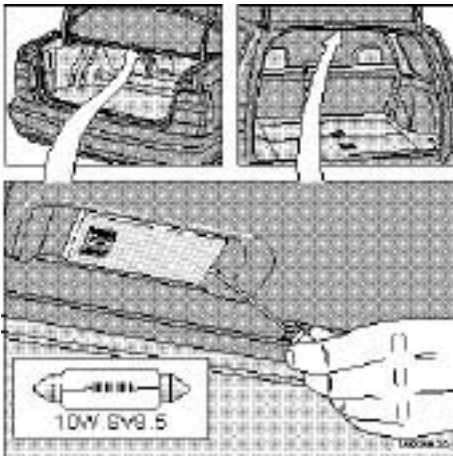

Insert screwdriver and turn

Trunk light (sedans)/Rear courtesy light (wagons)

- Switch off the lights.
- Press in the catch with a screwdriver and remove the bulb holder.
- Replace the bulb and reinstall the bulb holder.

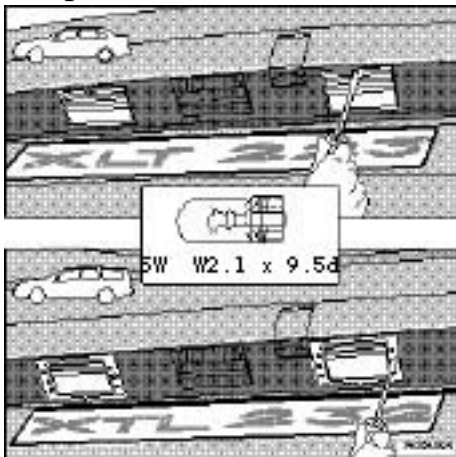

Torx screwdriver for glass lens

License plate lights (sedans and wagons)

- Switch off the lights.
- Unscrew the screw*.
- Insert the screwdriver and turn gently to loosen the glass lens.
- Replace the bulb and reinstall the glass lens.

* Two screws on wagons

pg. 102 Replacing bulbs

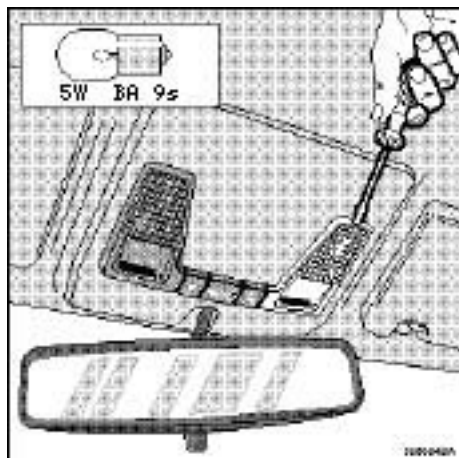

Insert screwdriver, turn and pull downward

Front courtesy lights

- Switch off the ignition.
- Insert a screwdriver and turn carefully to loosen the glass lens.
- Replace the bulb and press the glass lens back into place.

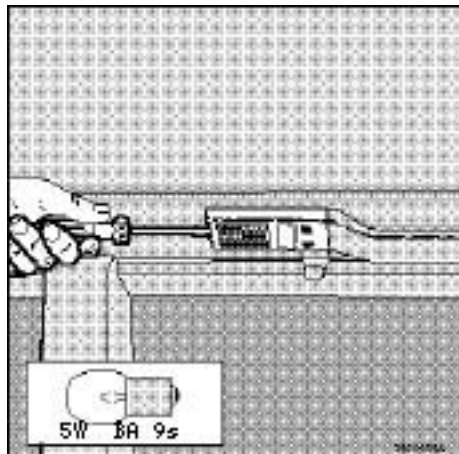

Insert a screwdriver and turn

Rear reading lights

- Switch off the ignition.
- Insert a screwdriver and turn to loosen the lamp unit.
- Replace the bulb and press the lamp unit back into place.

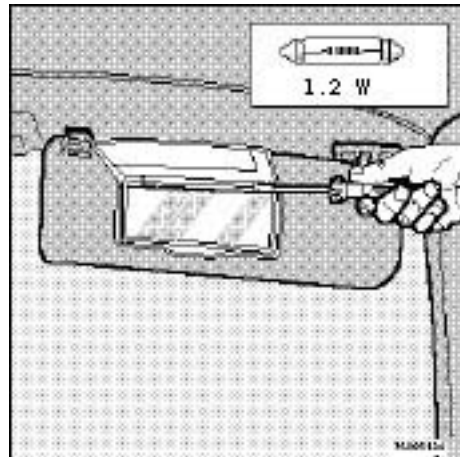

Insert a screwdriver and turn

Vanity mirror

- Switch off the ignition.
- Insert a screwdriver under the lower edge and turn to loosen the glass lens.
- Push out the bulb and replace it.
- Press the lower edge of the lens into place above the four catches.
- Press the upper edge of the lens into place.

pg. 103 Replacing bulbs

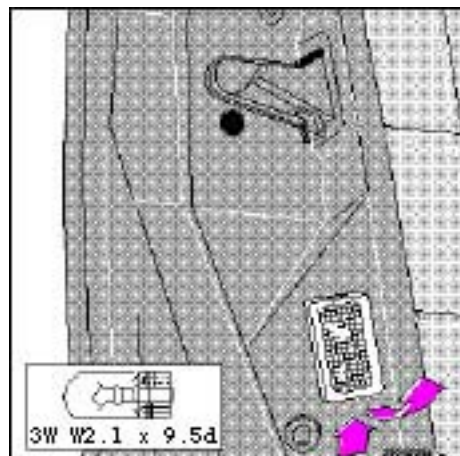

Insert the screwdriver and turn gently (rear door)

Door warning lights

- Slide the lamp unit upward and pull out the lower edge.
- Twist off the bulb holder.

- Pull the bulb straight out.
- Replace the bulb.
- Reinstall the holder and lamp unit in reverse order.

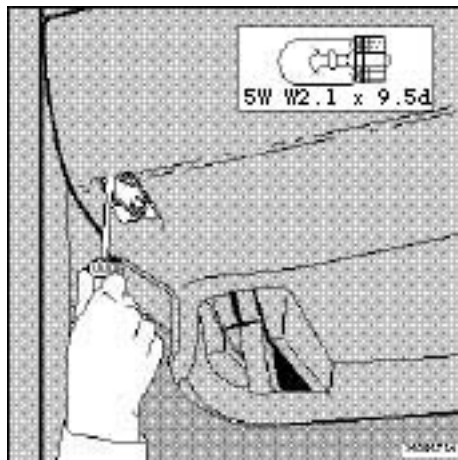

Insert a screwdriver

Door step courtesy lights

- Insert a screwdriver and pry out the glass lens.
- Withdraw the lamp unit, bend back the tabs and remove the plate.
- Replace the bulb.
- Reinstall the plate.
- Press the lamp unit back into place.

NOTE: Other bulbs may be difficult for the owner to replace. Let your Volvo retailer replace these bulbs if necessary.

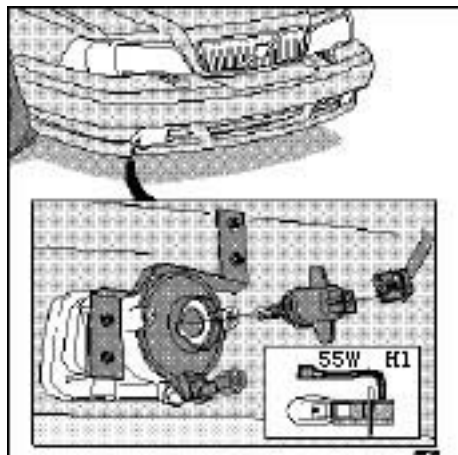

Front fog lights in spoiler

Front fog lights (option)

- Switch off the lights
- Turn the plastic cover counter-clockwise to remove it.
- Press the spring toward the lamp unit to release it and move it to the side.

- Replace the bulb.
- Reinstall in reverse order.

pg. 104 Replacing fuses

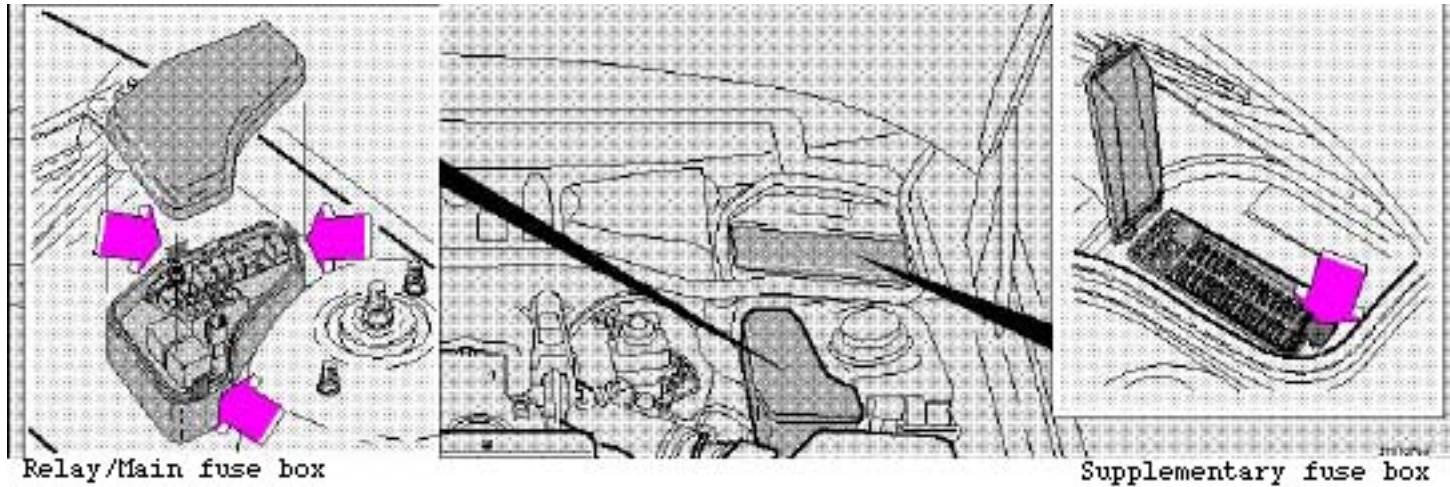

Replacing fuses

If an electrical component fails to function, it is likely that a fuse has blown due to a temporary circuit overload.

The fuse boxes are located in the engine compartment (see illustration) and can be opened by pressing the catches and lifting the cover (Relay/Main fuse box) or by lifting the cover (supplementary fuse box).

A label on the inside of each cover indicates the amperage and the electrical components that are connected to each fuse.

The easiest way to see if a fuse is blown is to remove it *. Pull the fuse straight out. From the side, examine the curved metal wire to see if it is broken. If so, put in a new fuse of the same color and amperage (written on the fuse). Spare fuses are stored in a compartment in the Supplementary fuse box. If fuses burn out repeatedly, have the electrical system tested at a Volvo retailer. If you find it difficult to remove a fuse, you will find a special fuse tool clipped in the fuse box.

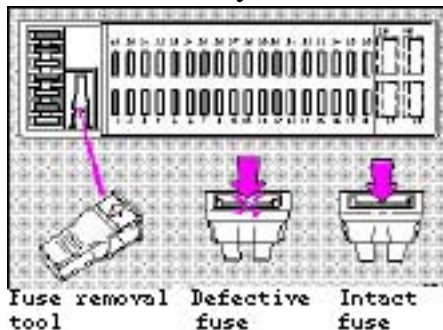

* Fuses in the Relay/Main fuse box should only be changed by an authorized Volvo service technician.

pg. 105 Fuses

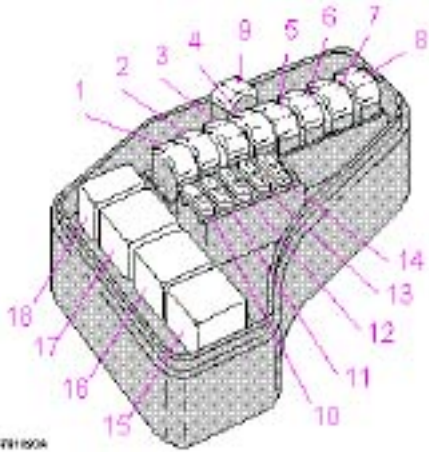

Relay/Main fuse box

Fuses in the main fuse box protect the entire electrical system. If one of the fuses blows, there is a serious electrical fault. Do not change any of these fuses. Contact your nearest Volvo workshop for a closer analysis.

Relays

15 System relay

16 Air pump relay

17 Starter motor

18 Air conditioning

Fuses in Relay/Main fuse box (main system fuses)

Location *	Amperage
1 Electric cooling fan	60A
2 Fuses in Supplementary fuse box	50A
3 Starter motor, air pump	50A
4 ABS, STC, TRACS	50A
5 Headlights	50A

6 Fuses in Supplementary fuse box	60A
7 Fuses in Supplementary fuse box	60A
8 Control modules - engine/automatic transmission	60A
9 Electrically operated windows	60A
10 Ignition switch, Control modules - engine/automatic transmission	10A
11 Fuel injectors, A/C relay	10A
12 Fuel pump, fuel injection system	20A
13 Control module - automatic transmission	10A
14 A/C relay, emissions systems	10A

* Some of the equipment/systems listed may be available on certain models only.

pg. 106 Fuses (supplementary fuse box)

Location *	Amperage
1 -	
2 Central locking, driving mode selectors (aut. trans.)	10A
3 ABS	10A
4 Immobilizer (Canada only)	10A
5 Climate systems, Onboard diagnostics OBDII	15A
6 -	
7 Audio system	15A
8 Immobilizer (Canada only), trip computer, headlight switch	15A
9 Electrically heated rear seat (certain models)	20A
10 Ignition switch	15A
11 Brake lights	10A
12 -	
13 Hazard warning flashers, headlight flashers, remote operated central locking system	15A
14 Heated rear window and door mirrors	30A
15 Courtesy lights, door open warning lights, trunk/cargo space light, seat belt reminder, glove compartment light	10A
16 Power antenna, electrical connector for trailer, accessories	30A
17 Front fog lights	20A

18 Key reminder	10A
19 Left high beam	15A
20 Right high beam, high beam indicator light	15A
21 Left low beam	15A
22 Right low beam	15A
23 Left front/rear parking lights, left tail light, license plate lights	10A
24 Right front/rear parking lights, right tail light	10A
25 Rear fog light, rear fog light indicator lamp	10A
26 Headlight switch	15A
27 Backup lights, turn signals	15A
28 Heated seats - front/rear (certain models)	25A
29 Heated rear window, shiftlock, seat belt reminder, cruise control, heated door mirrors, bulb failure warning sensor	10A
30 -	
31 Passenger compartment blower-climate systems	25A
32 Audio system	10A
33 Tailgate wiper/washer	15A
34 Windshield wipers/washers, horn	25A
35 Instrument lighting, accessories, power sun roof	10A
36 Rear auxiliary socket, power seats	15A
37 Power windows, power sun roof	AUT/CB**
38 -	
39 Power seat (driver's side)	AUT/CB**
40 Power seat (passenger's side)	AUT/CB**

* Some of the equipment/systems listed may be available on certain models only.

** This is an automatic circuit breaker located in the fuse box and does not normally need to be replaced.

For more detailed information concerning function and location of relays, fuses, etc., refer to the Volvo Service Manuals. These can be purchased through your Volvo retailer.

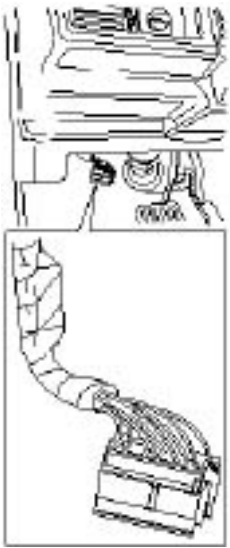

Installation of accessories

In order to help avoid interference and damage to your car's electrical system, the car is equipped with an accessory connector located under the instrument panel on the driver's side.

Please consult your Volvo retailer if you have any questions before connecting accessory or optional equipment to the vehicle's electrical system.

Connector (for accessories)

Position	Connection	Max. load
1	Battery +(30)	20 A
2	X Supply	0,5 A
3	High beam	1 A
4	-	1 A
5	-	1 A
6	Rheostat	0,5 A
7	-	2 A
8	Earth (31)	-

pg. 108 Replacing wiper blades

Replacing wiper blades

Lift the wiper arm off the windshield and hold the blade at right angles to the arm. Pinch the end of the plastic clip located at the back of the arm.

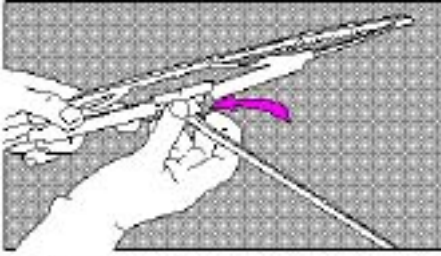

Slide the wiper blade along the arm to release it from the hook.

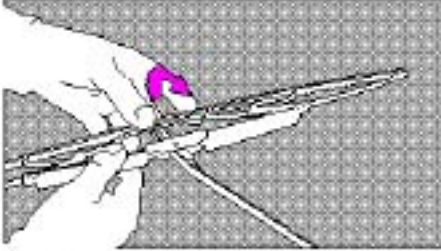

Install the new blade (installation is the reverse of removal) and make sure that it is properly attached to the wiper arm.

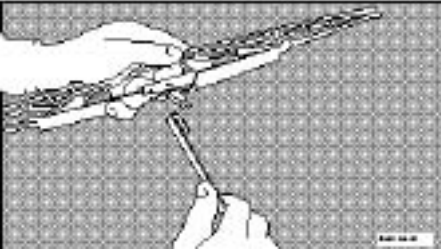

NOTE: For reasons of safety, you should change the windshield wiper blades as soon as they start to leave marks on the windshield or fail to wipe efficiently and cleanly.

To obtain maximum lifetime from a set of wiper blades, clean them with a stiffbristle brush and warm, soapy water as part of a normal car wash.

pg. 109 Replacing headlight wiper blades

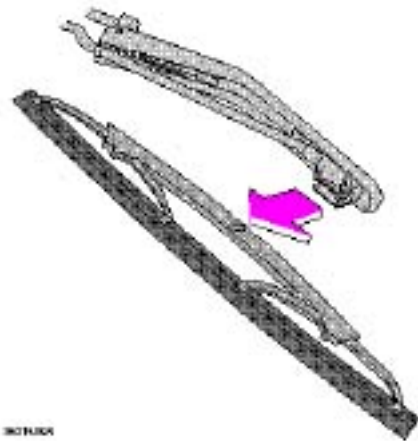

Replacing headlight wiper blades (certain models)

Pull the wiper blade in the direction indicated by the arrow in the illustration to remove it. Press the new wiper blade into place. Check that the new blade is properly attached to the wiper arm.

Cleaning the outside of the windshield and wiper blades

If the windshield/tailgate is not clear after using the wiper(s) or if the blade chatters when running, wax or other material may be on the blade or on the surface of the glass.

Clean the glass with a suitable cleaning agent. The glass is clean if beads do not form when you rinse it with water.

Clean the wiper blade by wiping vigorously with a cloth soaked in full strength windshield washer solvent. Then rinse the blade with water.

Wiper blades should be checked on a regular basis and replaced when worn.

pg. 110 In case of emergency



Shiftlock release (automatic transmission only)

The gear selector is locked in the (P)ark position. To manually release the shiftlock:

- Turn the starting (ignition) key to position I
- Press firmly on the "SHIFTLOCK OVERRIDE" button located to the right of the base of the gear selector
- While holding the override button down, press the button on the front of the gear selector
- Move the selector from the (P)ark position.

Electrically operated windows

The electrically operated window motors have an overload protecting circuit breaker (fuse no. 37) which is activated when an object blocks a window. Should this occur, remove the object and wait 20 seconds

for the circuit breaker to reset.

The electrically operated windows should then function.

Sun roof

The electrically operated sun roof has an overload protecting circuit breaker (fuse no. 37) which is activated when an object blocks the sun roof. Should this occur, remove the object and wait 20 seconds for the circuit breaker to reset. The sun roof should then function normally. Also check fuse no. 35.

Electrically operated front seats

The electrically operated front seats have overload protecting circuit breakers (fuses no. 39 and 40) which are activated when an object blocks one of the seats. Should this occur, remove the object and wait 20 seconds for the circuit breaker to reset. The seat should then function normally.



[Contents](#) | [Top of Page](#)

2000 VOLVO S & V70

Chapter 7 - Car care

pg. 111 Car care

Car care includes not only maintaining the appearance of the car, but also protecting the car exterior from the effects of air pollution, rain, mud or road salt. The paintwork should also be touched up immediately, if damaged, to prevent rust formation.

Paint touchup	112-113
Washing	114
Automatic car washing, Polishing and waxing	115
Cleaning the upholstery	116

pg. 112 Paint touch up

Paint touchup

Paint damage requires immediate attention to avoid rusting. Make it a habit to check the finish regularly when washing the car for instance. Touchup if necessary.

Paint repairs require special equipment and skill. Contact your Volvo retailer for any extensive damage.

Minor scratches can be repaired by using Volvo touchup paint.

NOTE: When ordering touchup paint from your Volvo retailer, use the paint code indicated on the model plate. The plate is located in the engine compartment, on the inside of the left front fender.



Extra Paint code for two-tone XC AWD models

Paint code

Minor stone chips and scratches

Material:

Primer can

Paint touchup bottle

Brush

Masking tape

NOTE: When touching up the car, it should be clean and dry. The surface temperature should be above 60° F (15° C).

Scratches on the surface

If the stone chip has not penetrated down to the metal and an undamaged layer of paint remains, the touchup paint can be applied as soon as the spot has been cleaned.

pg.113 Paint touch up

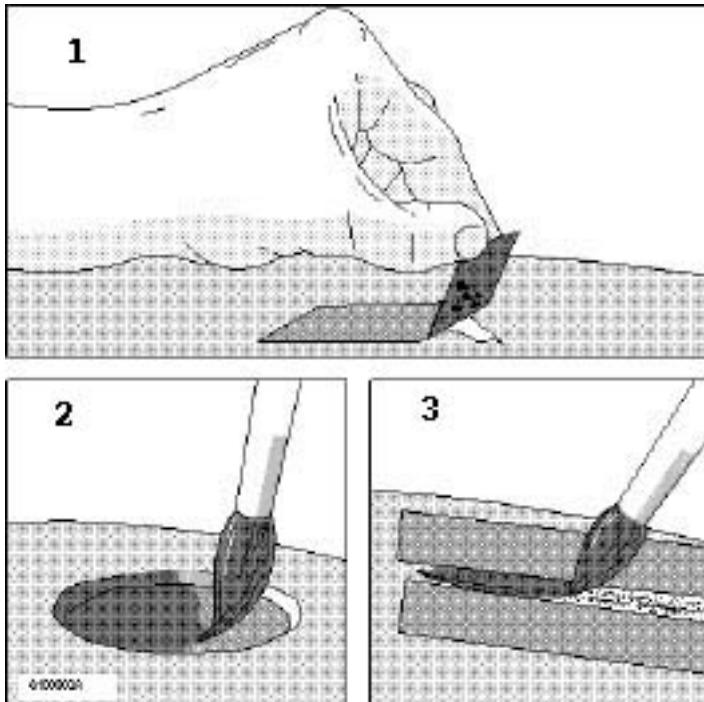

Deep scratches

1. Place a strip of masking tape over the damaged surface. Pull the tape off so that any loose flakes of paint adhere to it.
2. Thoroughly mix the primer and apply it with a small brush.
When the primer surface is dry, the paint can be applied using a brush. Mix the paint thoroughly; apply several thin paint coats and let dry after each application.
3. If there is a longer scratch, you may want to protect surrounding paint by masking it off.

pg. 114 Washing

Washing the car

- The car should be washed at regular intervals since dirt, dust, insects and tar spots adhere to the paint and may cause damage.

NOTE: It is particularly important to wash the car frequently in the wintertime to prevent corrosion, when salt has been used on the roads.

- When washing the car, do not expose it to direct sunlight. Use lukewarm water to soften the dirt before you wash with a sponge, and plenty of water, to avoid scratching.
- **Bird droppings:** Remove from paintwork as soon as possible. Otherwise the finish may be permanently damaged.
- A detergent can be used to facilitate the softening of dirt and oil.
- A water-soluble grease solvent may be used in cases of sticky dirt. However, use a wash place equipped with a drainage separator.
- Dry the car with a clean chamois and remember to clean the drain holes in the doors and rocker panels*.
- The power radio antenna (sedans) must be dried after washing.
- Tar spots can be removed with kerosene or tar remover after the car has been washed.
- A stiff-bristle brush and lukewarm soapy water can be used to clean the wiper blades. Frequent cleaning improves visibility considerably.
- Wash off the dirt from the underside (wheel housings fenders, etc.).
- In areas of high industrial fallout, more frequent washing is recommended.

CAUTION: During high pressure washing, the spray mouthpiece must never be closer to the vehicle than 13" (30 cm). Do not spray into the locks.

- When washing or steam cleaning the engine, avoid spraying water or steam directly on the electrical components or toward the rear side of the engine.
- After cleaning the engine, the spark plug wells should be inspected for water and blown dry if necessary.

Suitable detergents

Special car washing detergents should be used. A suitable mixture is about 2.5 fl. oz. (8.5 cl) of detergent to 2.6 US gal. (10 liters) of warm water. After washing with a detergent the car should be well rinsed with clean water.

WARNING!

- When the car is driven immediately after being washed, apply the brakes several times in order to remove any moisture from the brake linings.
- Engine cleaning agents should not be used when the engine is warm. This constitutes a fire risk.

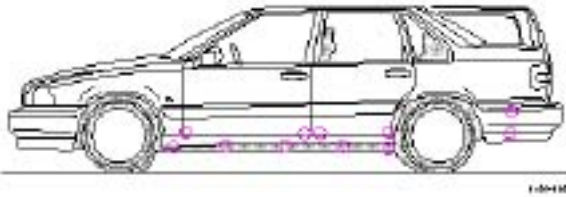

NOTE: When washing the car, remember to remove dirt from the drain holes in the doors and sills.
Bumpers: Wash the bumpers with the same cleaning agent used on the rest of the car. Never clean the bumpers with gasoline or paint thinner. Difficult spots can be removed with denatured alcohol. To avoid scratches, do not dry the bumpers with paper.

* Pay special attention to the drain holes near the base of the windshield, under the rear edge of the hood.

pg. 115 Automatic car washing, Polishing and waxing

Automatic washing simple and quick

An automatic wash is a simple and quick way to clean your car, but it is worth remembering that it may not be as thorough as when you yourself go over the car with sponge and water. Keeping the underbody clean is most important, especially in the winter. Some automatic washers do not have facilities for washing the underbody.

Before driving into an automatic wash, make sure that side view mirrors, auxiliary lamps, etc., are secure, otherwise there is risk of the machine dislodging them. You should also lower the antenna (sedans).

We do NOT recommend washing your car in an automatic wash during the first six months (because the paint will not have hardened sufficiently).

Polishing and waxing

Normally, polishing is not required during the first year after delivery, however, waxing may be beneficial.

Before applying polish or wax the car must be washed and dried. Tar spots can be removed with kerosene or tar remover. Difficult spots may require a fine rubbing compound.

After polishing use liquid or paste wax.

Several commercially available products contain both polish and wax.

Waxing alone does not substitute for polishing of a dull surface.

A wide range of polymerbased car waxes can be purchased today. These waxes are easy to use and produce a longlasting, highgloss finish that protects the bodywork against oxidation, road dirt and fading.

pg. 116 Cleaning the upholstery

Cleaning the upholstery

The **fabric** can be cleaned with soapy water or a detergent. For more difficult spots caused by oil, ice cream, shoe polish, grease, etc., use a clothing/fabric stain remover.

The **plastic** in the upholstery can be cleaned with a soft cloth and mild soap solution.

Leather upholstery/suede-like upholstery (alcantera™) can be cleaned with a soft cloth and mild soap solution. For more difficult spots, Volvo offers a leather care kit.

On no account must gasoline, naphtha or similar cleaning agents be used on the plastic or the leather since these can cause damage.

Cleaning the seat belts

Clean only with lukewarm water and mild soap solution.

Cleaning floor mats

The floor mats should be vacuumed or brushed clean regularly, especially during winter when they should be taken out for drying. Spots on textile mats can be removed with a mild detergent.

Bear in mind

- Take extra care when removing stains such as ink or lipstick since the coloring can spread.
- Use solvents sparingly. Too much solvent can damage the seat padding.
- Start from the outside of the stain and work toward the center.



[Contents](#) | [Top of Page](#)

2000 VOLVO S & V70

Chapter 8 - Volvo Service

pg. 117 Service an investment

An investment which will pay dividends in the form of improved reliability, durability and resale value.

Label information	118
Maintenance service, Warranty	119
Maintenance schedule	120- 121
Servicing	122- 123
Fuel/emissions systems	124
Lubrication	125
Engine oil	126- 127
Power steering fluid, Brake/clutch system fluid reservoir	128
Windshield washer nozzle, Washer fluid reservoir	129
Coolant	130
Engine compartment	131
Battery maintenance	132

pg. 118 Label information

1 Vehicle Emission Control Information

Your Volvo is designed to meet all applicable emission standards, as evidenced by the certification label

on the underside of the hood. For further information regarding these regulations, please consult your Volvo retailer.

2 Vacuum hose routing

(underside of hood)

3 Loads and Tire Pressures

(on inside of fuel tank cover)

4 Model plate

Vehicle Identification Number (VIN). Codes for color and upholstery, etc. The plate is located in the engine compartment, on the inside of the left front fender.

5 Vehicle Identification Number (VIN) *

The VIN plate is located on the top left surface of the dashboard. The VIN is also stamped on the right hand door pillar.

6 Federal Motor Vehicle Safety Standards (FMVSS) specifications (USA) and Ministry of Transport (CMVSS) standards (Canada)

Your Volvo is designed to meet all applicable safety standards, as evidenced by the certification label on the facing side of the driver's door. For further information regarding these regulations, please consult your Volvo retailer.

7 Child safety latch label

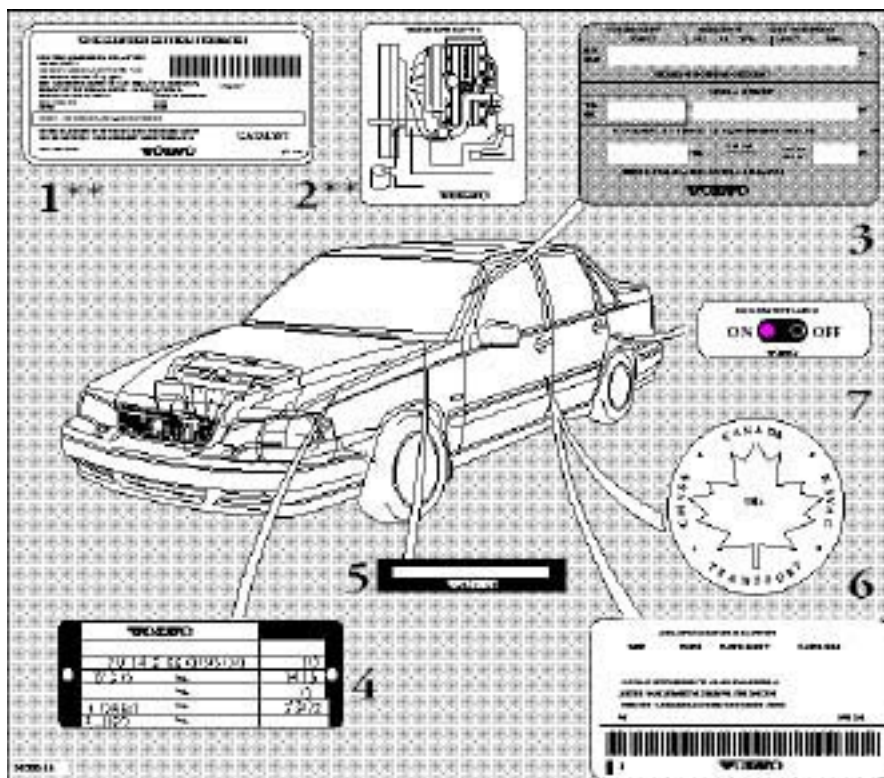

* The Vehicle Identification Number (VIN) should always be quoted in all correspondence concerning your vehicle with the retailer and when ordering parts.

** These decals are located on the underside of the hood.

All specifications are subject to change without notice.

pg. 119 Maintenance service, Warranty

Maintenance service

Volvo advises you to follow the service program which is outlined in the "Maintenance Records Manual". This maintenance program contains inspections and services necessary for the proper function of your car. The maintenance services contain several checks which require special instruments and tools and therefore must be performed by a qualified technician. To keep your Volvo in top condition, specify time tested and proven Genuine Volvo Parts and Accessories.

The Federal Clean Air Act U.S.

The Clean Air Act requires vehicle manufacturers to furnish written instructions to the ultimate purchaser to assure the proper functioning of those components that control emissions. The maintenance instructions listed in the "Servicing" section of this Manual represent the minimum maintenance required. These services are not covered by the warranty. You will be required to pay for labor and

material used. Refer to your Warranty booklet for further details.

Maintenance services

Your Volvo has passed several major inspections before being delivered to you, according to Volvo specifications. The maintenance services outlined in this book should be performed as indicated. The extended maintenance service intervals make it even more advisable to follow this program. Inspection and service should also be performed any time a malfunction is observed or suspected. It is recommended that receipts for vehicle emission services be retained in the event that questions arise concerning maintenance. See your "Maintenance Records Manual".

Applicable warranties U.S.

In accordance with U.S. Federal Regulations, the following list of applicable U.S. warranties is provided. For Canadian specification vehicles, see your separate warranty booklet.

- New Car Limited Warranty
- Parts and Accessories Limited Warranty
- Corrosion Protection Limited Warranty
- Seat belt and Supplemental Restraint Systems Limited Warranty
- Emission Design and Defect Warranty
- Emission Performance Warranty

These are the Federal warranties; other warranties are provided as required by state law. Refer to your separate Warranty booklet for detailed information concerning each of the warranties.

pg. 120 Maintenance schedule

2000 MAINTENANCE SCHEDULE S & 70

**For complete maintenance information, please refer to your
Warranty and Service Records Information Booklet.**

- A**= Adjust (Correct if necessary)
- R**= Replace
- I**= Inspect (Correct or Replace if necessary)
- L**= Lubricate

Maintenance Operation	thousand miles	7.5	15	22.5	30	37.5	45	52.5	60	67.5	75	82.5	90 ²
	(thousand km)	(12)	(24)	(36)	(48)	(60)	(72)	(84)	(96)	(108)	(120)	(132)	(144)
EMISSION SYSTEM MAINTENANCE													
Engine oil and filter ¹		R	R	R	R	R	R	R	R	R	R	R	R
Engine drive belt (accessory belt) ²									R				
Air cleaner filter					R				R				R
Spark plugs					R				R				R
Automatic transmission fluid			I		I				I			I	I
Timing belt - all engines ³													

1) See section "Engine oil" for detailed information.

NOTE: The oil should be changed at these intervals, after 750 hours of driving or after 12 months, whichever occurs first.

2) For services beyond 90,000 miles (144,000 km), please refer to the Warranty and Service Records Information Booklet".

3) For proper functioning of the vehicle and its emission control systems, the timing belt and tensioner must be replaced every 105,000 miles (168,000 km).

pg. 121 Maintenance schedule

2000 MAINTENANCE SCHEDULE S & V70

A= Adjust (Correct if necessary)

R= Replace

I= Inspect (Correct or Replace if necessary)

L= Lubricate

Maintenance Operation	thousand miles	7.5	15	22.5	30	37.5	45	52.5	60	67.5	75	82.5	90
	(thousand km)	(12)	(24)	(36)	(48)	(60)	(72)	(84)	(96)	(108)	(120)	(132)	(144)
EMISSION SYSTEM MAINTENANCE													
Engine													
Fuel line filter ¹													
PCV nipple (orifice)/hoses, clean								I					I
Battery (check charge and electrolyte level)	I	I	I	I	I	I	I	I	I	I	I	I	I
Brakes													
Inspect brake pads, replace components as necessary		I	I	I	I	I	I	I	I	I	I	I	I
Brake fluid level ² - check		I		I		I		I		I		I	
Steering/suspension													
Tires ³ , check pressure, wear and condition	I	I	I	I	I	I	I	I	I	I	I	I	I
Check power steering fluid level				I		I		I		I		I	
Body													
Power antenna (clean)		L		L		L		L		L		L	
Trunk/hood, hinges and latches				L				L					L
Cabin air filter (see page 121)		R		R		R		R		R		R	

1) Replace at 105,000 miles (168,000 km)

2) Brake fluid should be changed at owner request every second year or 30,000 miles (48,000 km). The fluid should be replaced once a year or every 15,000 miles (24,000 km) when driving under extremely hard conditions (mountain driving, etc.).

3) Rotate tires at owner request.

The following items should be checked weekly by the driver (it takes only a few minutes):

Engine oil level, brake fluid level, radiator coolant level, operation of all lights, horns, windshield wipers, tire pressure (all five tires), windshield washer fluid level

The following should also be carried out at regular intervals:

Washing (check all drain holes), polishing, cleaning

pg. 122 Servicing

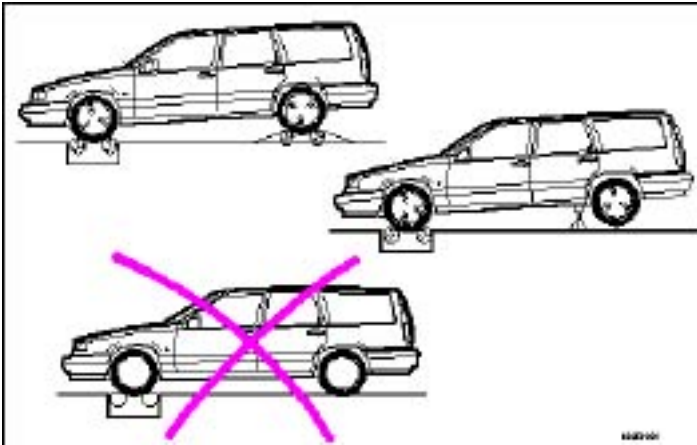

Rolling road (spin) test (models with AWD and viscous coupling)

When checking brakes using a rolling road (spin) test, or when balancing the wheels directly on the car, the other wheels must be free to roll, see illustration. This ensures that the viscous coupling is not damaged. The drive power is transferred automatically by the viscous coupling to the car's other drive wheels. If you are unsure, consult your nearest Volvo retailer.

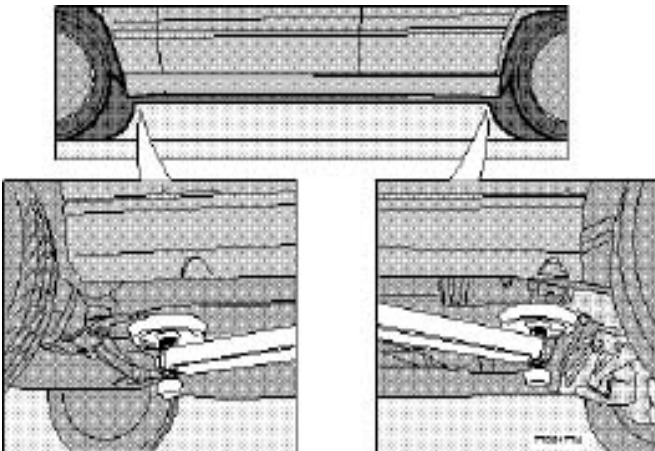

Hoisting the car

If a garage jack is used to lift the car, the two jack attachments points should be used. They are specially reinforced to bear the weight of the car. A garage jack can also be placed under the front of the engine support frame and under the reinforced plate in the spare wheel well. Take care not to damage the splash guard under the engine. **Ensure that the jack is positioned so that the car cannot slide off it. Always use axle stands or similar structures.**

If a twopost hoist is used to lift the car, the front and rear lift arm pads should be centered under the reinforced lift plates on the inboard edge of the sill rail. The position of these plates is marked with arrows molded into the bottom of the sill rail.

CAUTION: Certain models have reduced ground clearance due to the design of the front spoiler. Please observe caution when driving the car onto a garage hoist.

pg. 123 Servicing

Air cleaner

Replace the air cleaner cartridge with a new one every 30,000 miles (48,000 km). The cartridge should be replaced more often when driving under dirty and dusty conditions. The filter cannot be cleaned and therefore should always be replaced with a new one.

Timing belt

For proper functioning of the vehicle and its emission control systems, the timing belt and tensioner must be replaced every 105,000 miles (168,000 km). Engine damage will occur if the belt fails.

Fuel system cap, tank and lines and connections

The effectiveness of the fuel system to contain hydrocarbons is dependent largely on a leakfree system. Check for proper sealing of the fuel filler cap which contains "O" ring type seals.

NOTE: If the fuel filler cap is not closed tightly or if the engine is running when the car is refueled, the Malfunction Indicator Lamp ("Check Engine") may indicate a fault. However, your vehicle's performance will not be affected. Use only Volvo original or approved fuel filler caps.

Fuel (line) filter

For proper functioning of the vehicle and its emission control systems, the fuel line filter should be replaced at 105,000 miles (168,000 km). The filter is replaced as one complete unit. Replace more frequently if contaminated fuel is introduced into the tank (or if there is reason to suspect that this has occurred).

PCV system

The orifice nipple in the intake manifold and the filter at the end of the PCV hose in the air cleaner

should be inspected at 60,000 miles (96,000 km) and thereafter, at 30,000 mile (48,000 km) intervals.

Cabin air filter

Replace the cabin air filter with a new one at 15,000 mile (24,000 km) intervals. Volvo recommends replacing the filter more often if the car is driven under dirty and dusty conditions. The filter cannot be cleaned and therefore should always be replaced with a new one.



[Contents](#) | [Top of Page](#)

2000 VOLVO S & V70

pg. 124 Fuel/emissions systems

Fuel system

The fuel system is allelectronic and is microprocessorcontrolled. It can continually compensate for variation in engine load, speed and temperature to give the best economy and power. A mass air flow sensor measures the inducted air. In this way the system can make instantaneous adjustments for changes in air temperature or density, thus always assuring the best economy with the lowest possible exhaust emissions.

Heated oxygen sensor

This is an emission control system designed to reduce emissions and improve fuel economy. The heated oxygen sensor monitors the composition of the exhaust gases leaving the engine. The exhaust gas analysis is fed into an electronic module. This adjusts the airfuel ratio to provide optimum conditions for combustion and efficient reduction of the three major pollutants (hydrocarbons, carbon monoxide and oxides of nitrogen (NO_x) by a threeway catalytic converter.

Secondary Air Injection (certain models)

This system adds air to the hot exhaust gases as they are expelled from the engine. This causes a secondary combustion of residual hydrocarbons and carbon monoxide, resulting in lower emissions levels in the exhaust gases.

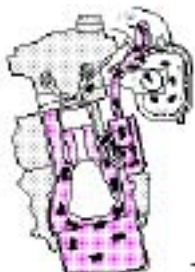

Crankcase ventilation

Crankcase ventilation

The engine is provided with positive crankcase ventilation which prevents crankcase gases from being released into the atmosphere. Instead, the crankcase gases are admitted to the intake manifold and

cylinders.

Evaporative control system

The car is equipped with an evaporative control system which prevents gasoline vapor from being released into the atmosphere.

The system consists of a fuel tank with filler pipe and cap, a rollover valve, a Fill Limit Vent Valve (FLVV), vapor vent lines, a charcoal canister, a purge line, a purge control valve and engine connections*.

In addition, there is a pressure sensor connected to the fuel tank and a filter-protected Canister Close Valve (CCV) on the atmospheric side of the canister, for system diagnosis.

The gasoline vapor is channeled through the rollover valve and the FLVV via the vapor vent lines into the charcoal canister, where it is stored. When the engine is started, the gasoline vapor is drawn from the charcoal canister to the engine's air intake system and into the combustion process.

NOTE:

- If the fuel filler cap is not closed tightly or if the engine is running when the car is refueled, the Malfunction Indicator Lamp may indicate a fault.
- During a transitional period, a small number of service stations may still have fuel nozzles that are not compatible with the fuel filler neck on cars equipped with the evaporative control system (ORVR) mandated by the U.S. Environmental Protection Agency and the California Air Resources Board. If you experience difficulties in refueling your vehicle, please ask the gas station attendant for assistance.

CAUTION:

Fuel must not be siphoned from the fuel tank. This will damage the Evaporative control system. *In the S70/V70 AWD (All Wheel Drive) the vent and rollover valve are integrated in an external FLVV/expansion tank.

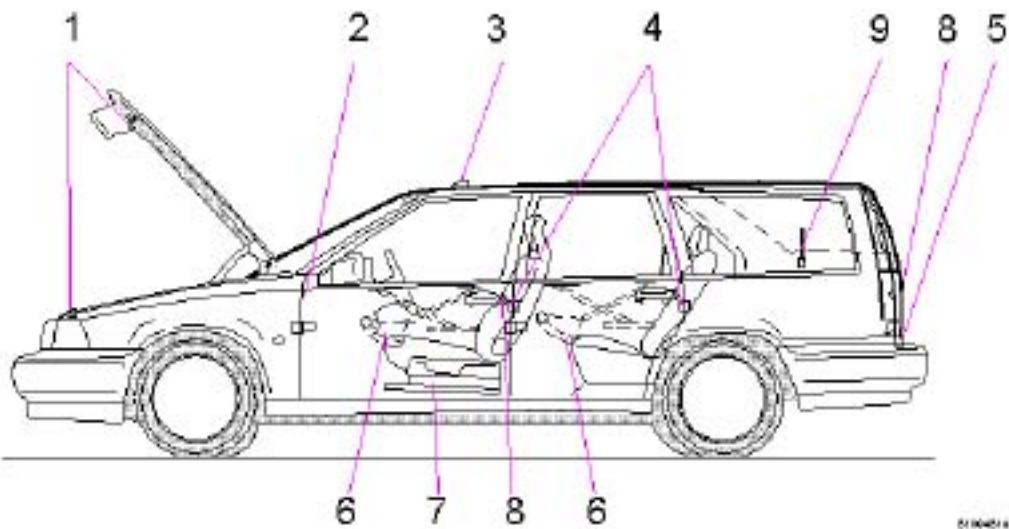

No. Lubrication point

- 1 Hood lock and latch
- 2 Door stop and hinges
- 3 Sun roof wind deflector (visible when sunroof is open)
- 4 Door lock catch plate
- 5 Trunk/tailgate lid lock
- 6 Window winder (on inside of door)
- 7 Front seat side rail and latch
- 8 Door locks
- 9 Power antenna (sedans only)

lubricant

- Oil
- Oil
- Oil Low temperature grease
- Oil
- Low temperature grease
- Oil, grease, low temperature grease
- Oil
- Volvo teflon lock spray
- WD 40 or similar

To avoid rattles and unnecessary wear, the body should be lubricated at regular service intervals. This should be done by an authorized Volvo retailer.

pg. 126 Engine oil

Checking the oil level

The oil level should be checked every time the car is refuelled. This is especially important during the period up to the first service.

CAUTION: Not checking the oil level regularly can result in serious engine damage if the oil level

becomes too low.

Park the car on a level surface and wait for at least 3 minutes after the engine has been switched off. Be sure the oil level is maintained between the upper and lower marks on the dipstick. If oil is added, it should reach the MAX mark on the dipstick. Low oil level can cause internal damage to the engine and overfilling can result in high oil consumption. The distance between the dipstick marks represents approx. 1.6 US qts (1.5 liters). The oil should preferably be checked when cold, before the engine has been started.

NOTE: The engine must be stopped when checking the oil.

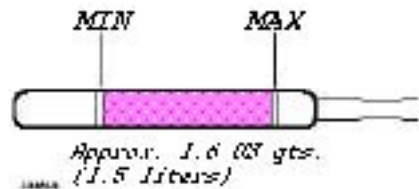

Draining the oil

Drain the oil after driving while it is still warm.

WARNING!

The oil may be very hot.

If you change the engine oil and filter yourself, your Volvo retailer can assist you in disposing of the used oil. Engine oil can be harmful to your skin gloves should be worn when performing this work.

To add or change oil

Add oil of the same kind as already used.

Capacity (including filter): 6.1 US qts (5.8 liters).*

The oil filter should be replaced at every oil change.

* Turbo-charged models: Add 0.95 qts (0.9 liters) if the oil cooler has been drained.

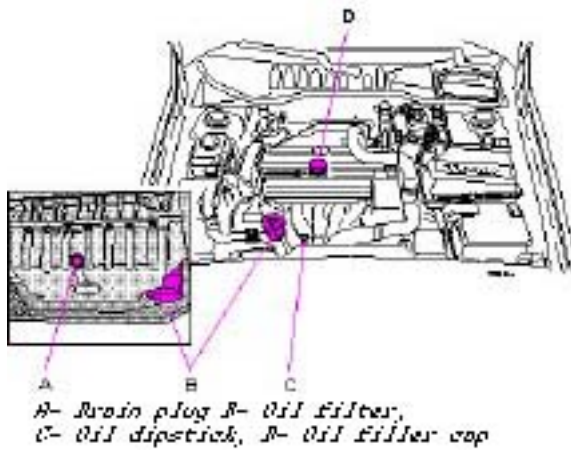
**WARNING!**

Oil spilled on a hot exhaust pipe constitutes a fire risk.

pg. 127 Engine oil

Oil quality**Meeting API specification SJ, SJ/CF, or SJ/Energy Conserving.**

For best fuel economy and engine protection, consult your authorized Volvo retailer for recommended oils. Oils with a different quality rating may not provide adequate engine protection.

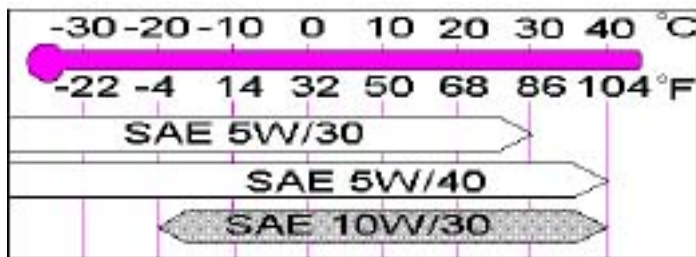
Viscosity (stable ambient temperatures)

Do not use oils with other viscosity ratings. Incorrect viscosity oil can shorten engine life. Volvo recommends the use of energyconserving oils. Look for the API label.

Viscosity (extreme conditions)

Under extreme operating conditions, such as trailer towing or prolonged driving in mountainous areas in

sustained ambient temperatures over 104 °F (40 °C), SAE 10W30 synthetic oil is recommended.

In areas where winter temperatures frequently fall below 14 °F (-10 °C), SAE 5W30 oil is recommended. If you use SAE 5W30, please note the upper temperature limit in the viscosity chart.

Changing oil and oil filter

Oil and oil filter changes should be made at 7,500 mile (12,000 km) intervals.

Extra oil additives must not be used unless advised by an authorized Volvo retailer.



American Petroleum Institute (API) labels.

These labels certify that the oil conforms to the applicable standards and specifications of the API.

* Synthetic oil is not used when the oil is changed at the normal maintenance service intervals.

pg. 128 Power steering fluid, Brake/clutch fluid reservoir

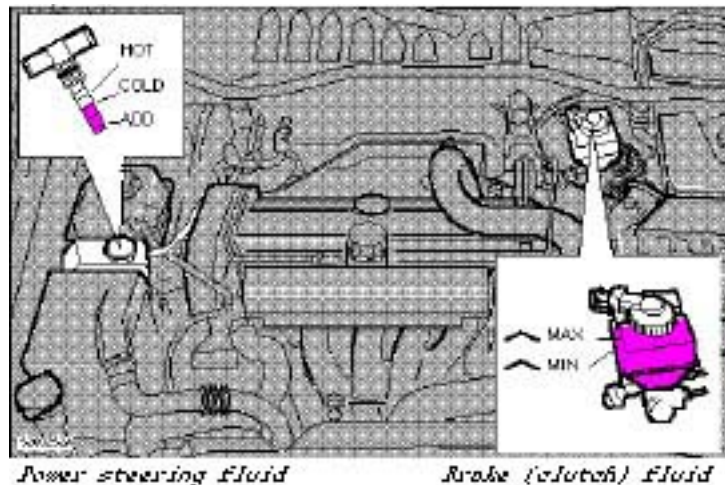

Power steering fluid

The dipstick has marks for checking hot and cold oil. The oil level when the engine is cold must never be higher than the **COLD** mark. After the engine has reached normal operating temperature, the level may not be higher than the **HOT** mark. Top up when the level is at the **ADD** mark. Check the level at every service.

Fluid type: ATF

Replace: No fluid change required

Brake and clutch systems

The brake and clutch systems share the same fluid reservoir. The fluid level should be between the MIN and MAX marks.

Fluid type: DOT 4+

Replace: Every second year or 30,000 miles (48,000 km). The fluid should be replaced once a year or every 15,000 miles (24,000 km) when driving under extremely hard conditions (mountain driving, etc.)

Check, without removing the cap, that the level is above the "**MIN**" mark of the fluid reservoir.

Always entrust brake/clutch fluid changing to an authorized Volvo retailer.

pg. 129 Windshield washer nozzles, Washer fluid reservoir

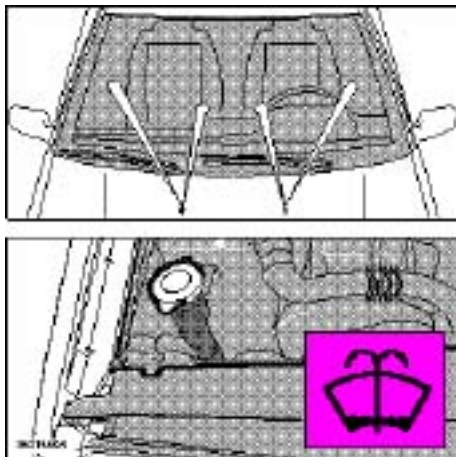

Adjusting washer nozzles

The washer jets should spray the windshield as shown in the illustration.

Washer fluid reservoir

The washer fluid reservoir is located in the engine compartment and holds approx. 3.2 US qts. (3.0 liters).

During cold weather, the reservoir should be filled with windshield washer solvent containing antifreeze.

pg. 130 Coolant

Check coolant level

The cooling system must be filled with coolant and not leak to operate at maximum efficiency. Check the coolant level regularly. The level should be between the "MAX" and "MIN" marks on the expansion tank. The check should be made with particular thoroughness when the engine is new or when the cooling system has been drained.

Do not remove the filler cap other than for topping up with coolant. Frequent removal may prevent coolant circulation between the engine and the expansion tank during engine warm up and cooling.

Capacity: Approx. 7.6 US qts. (7.2 liters)

Turbo-charged models 7.4 US qts. (7.0 liters)

Coolant: Volvo Genuine Coolant/Anti-freeze only.

NOTE: Do not top up with water only. Water by itself reduces the rustprotective and antifreeze qualities of the coolant and has a lower boiling point. It can also cause damage to the cooling system if it should freeze.

WARNING!

If the engine is warm and you are going to top up coolant, unscrew the tank cap slowly in order to allow any excess pressure to escape.

CAUTION: The cooling system must always be kept filled to the correct level. If it is not kept filled, there can be high local temperatures in the engine which could result in damage. Different types of antifreeze/coolant may not be mixed.

Engine compartment S/V 70

- 1 Supplementary fuse box
- 2 Expansion tank, coolant
- 3 Engine designation plate
- 4 Clutch/brake system fluid reservoir
- 5 Oil filler cap, engine
- 6 Relay/Main fuse box
- 7 Washer fluid reservoir
- 8 Power steering fluid reservoir
- 9 Dipstick engine oil
- 10 Dipstick automatic transmission
- 11 Air cleaner
- 12 Battery
- 13 Data plate

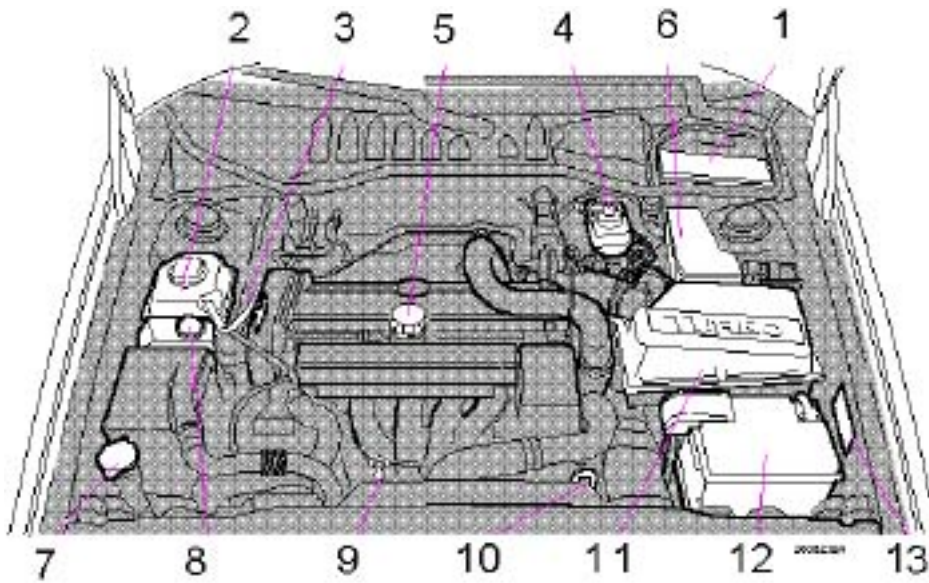

WARNING!

The coolant fan may start or continue to operate (for up to 6 minutes) after the engine has been switched off.

pg. 132 Battery maintenance

Original battery

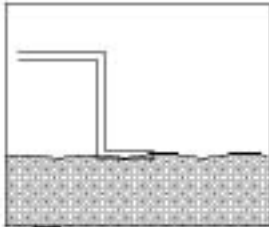

Replacement battery

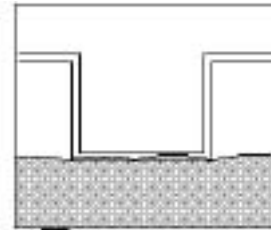

31000614



31000614

Correct fluid level

Battery maintenance

Driving habits and conditions, climate, the number of starts, etc. all affect the service life and function of the battery. In order for your battery to perform satisfactorily, keep the following in mind:

- Check the fluid level in the battery every 6 months or every 7,500 miles* (12,000 km).
- The fluid level in each battery cell should be checked - use a screw driver to open the caps and a flashlight to inspect the level.
- If necessary, add **distilled water** to approximately 0.4 in. (10 mm) above the plates in the cell or to the

level indicator. See the illustrations above.

- Check that the battery cables are correctly connected and properly tightened.
- Never disconnect the battery when the engine is running, for example when changing the battery.
- The battery cable should be disconnected from the battery when using a battery charger.
- Switch off the radio before disconnecting the battery. If your radio has an antitheft code and the battery is disconnected, the radio code has to be reentered in order for the radio to function. * More frequently in warm climates.

Battery warning symbols



Wear protection goggles



See inside for details



Keep away from children



Corrosive



No smoking, no open flames, no sparks



Explosion



[Contents](#) | [Top of Page](#)

2000 VOLVO S & V70

Chapter 9 - Specifications

pg. 133 Service an investment

This chapter contains facts and figures pertaining to the technical specifications of your car.

Oil/fluids specifications	134
Engine specifications	135
Cooling/fuel/distributor ignition systems	136
Front/rear suspensions	136
Transmission, Capacities, Vehicle loading	137
Electrical system/bulbs	138
Weights	139
Dimensions, Service manuals, Road assistance	140

pg. 134 Oil/fluid specifications

Oil quality

Meeting API specification SJ, SJ/CF, or SJ/Energy Conserving.

For best fuel economy and engine protection, consult your authorized Volvo retailer for recommended oils. Oil with a different quality rating may not provide adequate engine protection.

Synthetic oils complying with oil quality requirements are recommended for: driving in areas of sustained temperature extremes (hot or cold), when towing a trailer over long distances or for prolonged driving in mountainous areas.

Extra oil additives must not be used unless advised by an authorized Volvo retailer.

Viscosity (stable ambient temperatures):



Engine oil	Quality: Meeting API specification SJ, SJ/CF, or SJ/Energy Conserving	Capacity (incl. filter): 6.1 US qts (5.8 liters).*
Automatic transmission fluid	Quality: AW4: ATF Dexron III and Mercon. AW5: Only Volvo gearbox oil (1161540-8). Do not mix with other oils.	Capacity: 8 US qts. (7.6 liters) Capacity: 8 US qts. (7.5 liters)
Manual transmission fluid	Quality: Volvo synthetic gearbox oil 1161423	Capacity: 2.2 US qts. (2.1 liters)
Power steering fluid	Quality: ATF	Capacity: 0.95 US qts. (0.9 liters)
Brake fluid	Quality: DOT 4+	Capacity: 0.64 US qts. (0.6 liters)
All specifications are subject to change without notice.		

* Turbo-charged models: Add 0.95 qts. (0.9 liters) if the oil cooler has been drained

pg. 135 Engine

Engine

Liquid-cooled gasoline, 5cylinder, inline engine. Aluminum alloy cylinder block with cast iron cylinder liners cast directly into the block. Aluminum alloy cylinder head with double overhead camshafts and separate intake and outlet channels.

Engine lubrication is provided by an eccentric pump driven from the crankshaft. Fullflow type oil filter. Exhaust emission control is accomplished by multiport fuel injection, heated oxygen sensor(s) and threeway catalytic converter.

Designation: Volvo B 5244 S

Output	168 hp at 6100 rpm (125 KW 102 rps)
Max torque	170 ft. lbs. at 4800 rpm (230 Nm/80 rps)
Number of cylinders	5
Bore	3.27" (83 mm)
Stroke	3.54" (90 mm)
Displacement	2.4 liters
Compression ratio	10.3:1
Number of valves	20

Designation: Volvo B 5244 T

Output	190 hp at 5100 rpm (142 KW/85 rps)
Max torque	199 ft. lbs. at 1600-5000 rpm (270 Nm/27-83 rps)
Number of cylinders	5
Bore	3.27" (83 mm)
Stroke	3.54" (90 mm)
Displacement	2.4 liters
Compression ratio	9.0:1
Number of valves	20

Designation: Volvo B 5234 T3

Output	236 hp at 5400 rpm (176 KW/90 rps)
Max. torque	243 ft. lbs. at 2400-5100 rpm (330 Nm/4092 rps)
Number of cylinders	5
Bore	3.19" (81 mm)
Stroke	3.54" (90 mm)
Displacement	2.3 liters
Compression ratio	8.5:1
Number of valves	20

Designation: Volvo B 5244 T2

Output	261 hp at 5700 rpm (195 KW/95 rps)
Max. torque	258 ft. lbs. at 2400-5100 rpm (350 Nm/4085 rps)
Number of cylinders	5

Bore	3.19" (81 mm)
Stroke	3.54" (90 mm)
Displacement	2.3 liters
Compression ratio	8.5:1
Number of valves	20

All specifications are subject to change without notice.

pg. 136 Specifications

Cooling system

Type: Positive pressure, closed system

Thermostat begins to open at 186° F (90° C)

Turbo-charged models 180° F (87° C)

Coolant: Volvo original coolant/antifreeze

Capacity: 7.6 US qts. (7.2 liters)

Turbo-charged models 7.4 US qts. (7.0 liters)

Fuel system

The engine is equipped with a multiport fuel injection system.

Distributor ignition system

Firing order: 12453

Distributor ignition setting: Not adjustable

Spark plugs: Bosch FR7DC or Champion RC9YC

Spark plug gap: 0.028" (0.7 mm)

Turbo-charged models: Champion RC8PYP (or equivalent)

Spark plug gap: 0.03" (0.75 mm)

Tightening torque: 18.4 ft. lbs. +/- 3.7 ft. lbs. (25 Nm +/- 5 Nm)

WARNING!

The distributor ignition system operates at very high voltages. Special safety precautions must be followed to prevent injury. Always turn the ignition off when:

- Replacing distributor ignition components e.g. plugs, coil, etc.
- Do not touch any part of the distributor ignition system while the engine is running. This may result in unintended movements and body injury.

Replacing spark plugs

The spark plugs should be changed every 30,000 miles (48,000 km). However, city driving or fast highway driving may necessitate changing after 15,000 miles (24,000 km) of driving. When installing new plugs, be sure to fit the right type and use correct torque, see "Specifications". When changing the plugs, check that the suppressor connectors are in good condition. Cracked or damaged connectors should be replaced. When changing the spark plugs, clean the terminals and the rubber seals.

Front suspension

Spring strut suspension with integrated shock absorbers and control arms linked to the support frame. Powerassisted rack and pinion steering. Safety type steering column.

The alignment specifications apply to an unladen car but include fuel, coolant and spare wheel.

Toe-in measured on the wheel rims: 2.4 mm +/- 0.7 mm

Toe-in measured on tire sides: 2.9 +/- 0.9 mm

Rear suspension

Deltalink individual rear wheel suspension with longitudinal support arms, double link arms and track rods.

Toein measured on the tire sides: 4° +/- 10°

All specifications are subject to change without notice.

Power transmission

Manual transmission: M 56 H

Singledisc dry plate clutch. Allsynchromesh on all gears including reverse; integrated final drive. Operation via a floor mounted gear lever.

Final drive ratio 4.00:1

Reduction ratios

1st gear 3.07:1

2nd gear 1.77:1

3rd gear 1.19:1

4th gear 0.87:1

5th gear 0.70:1

Reverse 2.99:1

Automatic transmission: AW 5050 LE and AW 50-42 LE

4 or 5speed automatic electronically controlled gearbox comprising a hydraulic torque converter with a lockup function; planetary gear, integrated final drive.

Operation via a floor mounted gear selector lever. Drive shafts with symmetrical joint location. Overdrive.

Final drive ratio 2.76:1 (Turbocharged models: 2.56:1)

Reduction ratios AW5 AW4

1st gear 4.77:1 3.61:1

2nd gear 2.10:1 2.06:1

3rd gear 1.96:1 1.37:1

4th gear 1.32:1 0.98:1

5th gear 1.02:1

Reverse 3.23:1 3.95:1

All specifications are subject to change without notice.

All Wheel Drive, automatic transmission

4 or 5speed automatic electronically controlled gearbox comprising a hydraulic torque converter with a lockup function; planetary gear, integrated final drive. Bevel drive, propeller shaft, viscous coupling and freewheel to final drive/rear axle. Operation via a floor mounted gear selector lever. Overdrive.

Capacities

Fuel tank	18 US gal. (68 liters) - Front Wheel Drive 17.4 US gal (66 liters) - All Wheel Drive
Cooling system	7.4 US qts. (7.0 liters)
Engine oil (incl. filter)	6.1 US qts. (5.8 liters) *
Automatic transmission	2 US gals (7.6 liters)
Manual transmission	2.2 US qts. (2.1 liters)
Power steering fluid	0.8 US qts (0.8 liters)
Washer fluid reservoir	3.2 US qts. (3.0 liters)
Brake/clutch system	0.6 US qts (0.6 liters)

* Turbo-charged models: Add 0.95 US qt. (0.9 liters) if the oil cooler has been drained.

Vehicle loading

The tires on your Volvo should perform to specifications at all normal loads when inflated as recommended on the tire information label. The label is located on the inside of the fuel filler flap. The label lists both tire and vehicle design limits. Do not load your car beyond the load limits indicated.

WARNING!

Improperly inflated tires will reduce tire life, adversely affect vehicle handling and can possibly lead to failure resulting in loss of vehicle control without prior warning.

pg. 138 Specifications

Electrical system

12 Volt, negative ground.

Voltagecontrolled generator. Singlewire system with chassis and engine used as conductors.

Battery

Voltage: 12 Volt, capacity: 520 A/100 min (certain markets 420 A/75 min)

The battery contains corrosive and poisonous acids. It is of the utmost importance that old batteries are disposed of correctly. Your Volvo retailer can assist you in this matter.

Generator

Rated output: 1400 W, max. current: 100 A

Bulbs

Bulb	US no.	Power	Socket	No/bulbs
Headlights				
High beam	H7	55W	-	2
Low beam	H7	55W	-	2
Front parking lights/turn signals	3357NA	26/7W/30/2.2cp	W 2.5 x 15 q	2
Turn signals, rear	-	21W	BAU 15 s	2
Side direction indicators	-	5W	W 2.1x9.5 d	2
Tail lights (sedan)	67	5W/4cp	BA 15 s	4
Tail lights (wagon)	-	21/4W	BAZ 15 d	4
Brake lights	1156	21W/32cp	BA 15 s	2

Backup lights	1156	21W/32cp	BA 15 s	2
Rear fog light (sedan)	1156	21W/32cp	BA 15 s	1
Rear fog light (wagon)	-	21/4W	BAZ 15 d	1
Front fog lights	H1	55 W	-	2
License plate light	-	5 W	W 2.1x9.5 d	2
Door open warning light	-	3 W	W 2.1x9.5 d	4
Door step courtesy lights	-	5W	W 2.1x9.5 d	2
Trunk light	-	10 W	SV 8.5	1
Glove compartment light	-	2 W	BA 9 s	1
Vanity mirror lights	-	1.2 W	-	2
Instrument lighting	-	3 W	W 2.1x9.5 d	3
Illumination, control panel	-	1.2 W	W 2x4.6 d	
gear selector (automatic trans.)	-	1.2 W	W 2x4.6 d	1
rear ashtray	-	1.2 W	W 2x4.6 d	1
Instrument warning/indicator lights	-	1.2 W	W 2x4.6 d	
Front courtesy lights	-	5 W	BA 9 s	2
Rear reading lights	-	5 W	BA 9 s	2

All specifications are subject to change without notice.

pg. 139 Specifications

Gross Vehicle Weight (GVW):

FWD (sedan)	4180 lbs (1896 kg)	1900 kg
FWD (wagon)	4340 lbs (1969 kg)	1970 kg
FWD Turbo (sedan)	4250 lbs (1928 kg)	1930 kg
FWD Turbo (wagon) man	4340 lbs (1969 kg)	1970 kg
FWD Turbo (wagon) aut	4360 lbs (1978 kg)	1980 kg
AWD Turbo (sedan)	4580 lbs (2077 kg)	2080 kg

AWD Turbo (wagon)	4670 lbs (2118 kg)	2120 kg
-------------------	--------------------	---------

Capacity Weight:

FWD (sedan)	930 lbs (422 kg)	425 kg
FWD (wagon)	965 lbs (438 kg)	440 kg
FWD Turbo (sedan)	930 lbs (422 kg)	415 kg
FWD Turbo (wagon)	965 lbs (438 kg)	440 kg
AWD (sedan)	975 lbs (442 kg)	440 kg
AWD (wagon)	975 lbs (442 kg)	440 kg
AWD Turbo (sedan)	960 lbs (435 kg)	435 kg
AWD Turbo (wagon)	960 lbs (435kg)	435 kg

Permissible axle weight, front:

FWD (sedan, wagon) man	2240 lbs (1016 kg)	1020 kg
FWD (sedan, wagon) aut	2290 lbs (1039 kg)	1040 kg
FWD Turbo (sedan, wagon) man	2310 lbs (1048 kg)	1050 kg
FWD Turbo (sedan, wagon) aut	2350 lbs (1066 kg)	1070 kg
AWD Turbo (sedan, wagon) aut	2400 lbs (1089 kg)	1090 kg

Permissible axle weight, rear:

FWD (sedan)	2020 lbs (916 kg)	920 kg
FWD (wagon)	2220 lbs (1007 kg)	1010 kg

AWD (sedan)	2290 lbs (1039 kg)	1040 kg
AWD (wagon)	2470 lbs (1120 kg)	1120 kg
Curb weight	USA	Canada
(sedan FWD)	3140-3320 lbs (1424-1506 kg)	1425-1515 kg
(wagon FWD)	3230-3395 lbs (1465-1540 kg)	1465-1540 kg
(sedan AWD)	3530-3605 lbs (1601-1635 kg)	1600-1635 kg
(wagon AWD)	3695-3760 lbs (1676-1706 kg)	1695-1705 kg

Max roof load ** 220 lbs (100 kg) 100 kg

Max trailer weight

(w/o brakes) 1100 lbs (500 kg) 500 kg

(with brakes)

2" ball 3300 lbs (1500 kg) 1500 kg

1 7/8" ball 2000 lbs (908 kg) 900 kg

Max tongue weight

*** 165 lbs (75 kg) 75 kg

* The max permissible axle loads or the gross vehicle weight must not be exceeded.

** For permanent roof racks, check the manufacturer's weight specifications.

*** Please refer to section "Trailer towing"

WARNING!

When adding accessories, equipment, luggage and other cargo to your vehicle, the total loaded weight capacity of the vehicle must not be exceeded.

All specifications are subject to change without notice.

pg. 140 Dimensions, Road Assistance

Dimensions**FWD=Front Wheel Drive, AWD=All Wheel Drive**

Length	S 70 FWD	185.8 in. (472 cm)
	V 70 FWD/AWD	186.2 in. (473 cm)
	S 70 AWD	185.8 in. (472 cm)
	V 70 XC AWD	186.2 in. (473 cm)
Width	(all models)	69.3 in. (176 cm)
Height	S 70 FWD	54.7 in. (139 cm)
	V 70 FWD	55.5 in. (141 cm)
	S 70 AWD	56.3 in. (143 cm)
	V 70 AWD	57 in. (145 cm)
	V 70 XC AWD	58.3 in. (148 cm)
Wheel base	S/V 70 FWD	104.7 in. (266 cm)
	S/V 70 AWD	104.3 in. (265 cm)
	V 70 XC AWD	104.7 in. (266 cm)
Track, front	S/V 70 FWD	59.8 in. (152 cm)
	S/V 70 AWD	59.8 in. (152 cm)
	AWD/V 70 XC AWD	59.8 in. (152 cm)
Track, rear	S/V 70 FWD	57.9 in. (147 cm)
	S/V 70 AWD	58.7 in. (149 cm)
	V 70 XC AWD	58.7 in. (149 cm)
Turning circle (between curbs):	S/V 70 FWD	33.5-34.8 ft. (10.2-10.6 m)
	S/V 70 AWD	37.1 ft. (11.3 m)
	V 70 XC AWD	37.1 ft. (11.3 m)
Cargo capacity:	S 70 (seat up)	15.2 cu. ft. (0.43m ³)
	V 70 (seat up)	37.8 cu. ft. (0.90 m ³)
	V 70 (seat down)	69.2 cu. ft. (1.96 m ³)

The logo for Volvo's ONCALL program, featuring the word "VOLVO" in a bold, sans-serif font above the word "ONCALL" in a smaller, similar font, all contained within a black rectangular border.

Your new Volvo comes with a four year road assistance program named ONCALL. Additional information, features, and benefits are described in a separate information package in your glove compartment.

If you have misplaced your package, dial:

In the U.S.A.

1-800-63-VOLVO (1-800-638-6586)

In Canada:

1-800-263-0475



Volvo supports Voluntary Mechanic Certification by the A.S.E.(pertains to the USA only). Certified mechanics have demonstrated a high degree of competence in specific areas. Besides passing exams each mechanic must also have worked in the field for two or more years before a certificate is issued. These professional mechanics are fully able to analyze vehicle problems and perform the necessary service procedures to keep your Volvo at peak operating condition.

All specifications are subject to change without notice.



[Contents](#) | [Top of Page](#)

2000 VOLVO S & V70

Chapter 10 - Audio systems

pg. 141 Audio systems

This chapter describes the audio system in your car.

SC-813	142
SC-816	155
SC-901	171
General information	194

pg. 142 Audio system SC813 (certain models)

The following pages describe the use of your SC813 Cassette radio and CD remote control

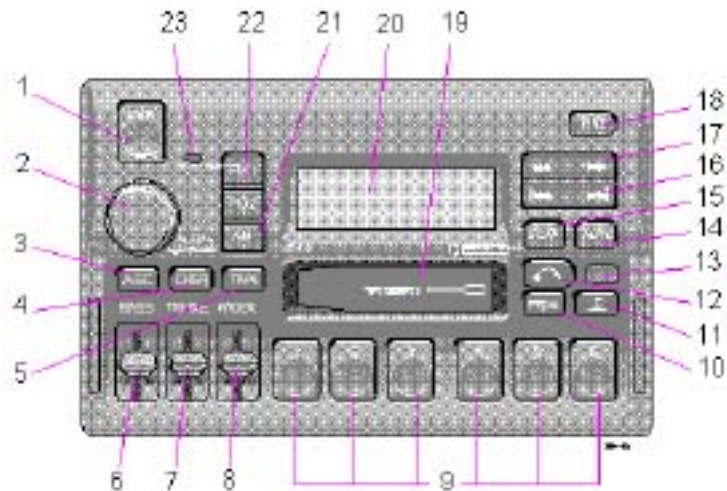

1. On/off (push)
2. Volume (turn)

- Pause/Mute (push)
- Balance (pull)

3. Active Sound Control

4. CD changer selector

5. · Tape mode selector
- Tape direction selector **PROG**

6. Bass control

7. Treble control

8. Fader control

9. · Preset buttons
- CD-Disc No. selector

10. **PROG** - Reversing the tape

11. Dolby B NR button

12. Cassette eject

13. Not in use

14. Scan

15. Auto seek memory

16. · Seek tuning up/down
- **TP**-Next/Previous song
 - **CD**-Next UP/Previous DOWN track

17. · Manual tuning
- **TP**-fast forward/Rewind
 - **CD**-Music searchUP/DOWN

18. RND button

19. Cassette slot

20. Display

21. Waveband selector (AM)

22. Waveband selectors (FM)

23. Anti-theft LED

TP = Applicable only in Tape Mode

CD = Applicable only when in CD mode and connected to a CD changer.

pg. 143 Anti-theft code



Anti-theft code

The radio features anti-theft circuitry. If the set is removed from the vehicle or if the battery power is disconnected, a special code must be entered to enable operation of the set.

Refer to the radio code card supplied with your vehicle or ask your Volvo retailer for the correct code.

When the car is parked with the ignition key removed, the anti-theft LED will flash.

Anti-theft LED

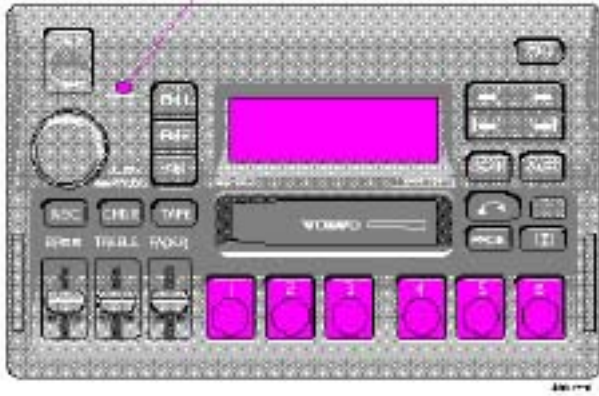

To enter the code

After installation or when the set has been disconnected from power, the set displays "COdE" when it is switched on.

Enter the 4-digit code using the preset buttons.

If the correct code is entered, "on" is displayed and the set is ready to use.

If you enter an incorrect code you must enter the correct code again from the beginning.



Incorrect code

If an incorrect code has been entered "rPt" is displayed. Enter the correct code.

After three unsuccessful coding attempts the set will lock and remain locked for two hours. **"OFF"** is displayed.

During this waiting period:

- the battery must be connected
- the ignition key must be turned to position I
- the unit must be turned on

Make sure the headlights are turned off to help prevent battery drain (please refer to [page 26](#) for information on turning the headlights off).

Enter the code again once this time has elapsed.

pg. 144 Radio SC-813

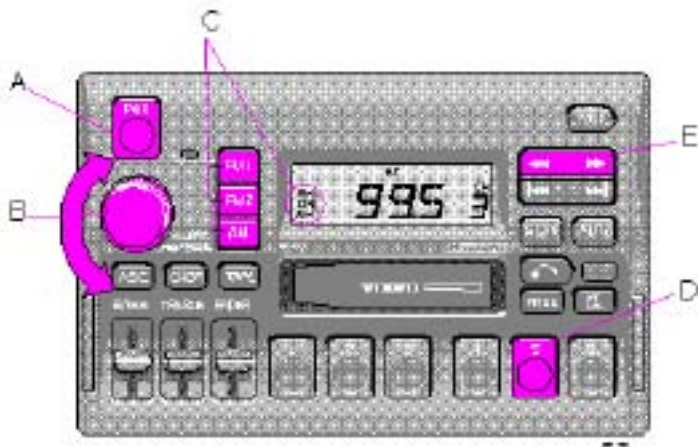

A - On/off switch

Push the button to switch on the radio. Press the button slightly longer to turn the radio off.

B - Volume control

Turn the button clockwise to increase the volume. The volume control is electronic and has no end stop.

C - Waveband selector

The desired waveband is set by pressing one of the waveband selector buttons. The frequency and waveband is shown on the display.

NOTE: There are two FM wavebands and one AM waveband. This makes it possible to store 2 x 6 FM stations and 6 AM stations in memory.

D - Setting frequency selection

The radio can be used in most parts of the world by changing the frequency selection intervals as follows:

Depress and hold preset button 5 and turn the radio ON. "USA" will flash on the display.

Each time button 5 is pressed, the frequency selection will change from "USA" to "AUS", etc. When the correct country name is displayed, wait 5 seconds and the radio will be

ready for use.

E - Manual tuning

Press the left side tune button to tune to lower frequencies and the right side to tune to higher frequencies. The tuned frequency is displayed.

ST will be displayed to indicate stereo FM reception.

pg. 145 Radio SC-813

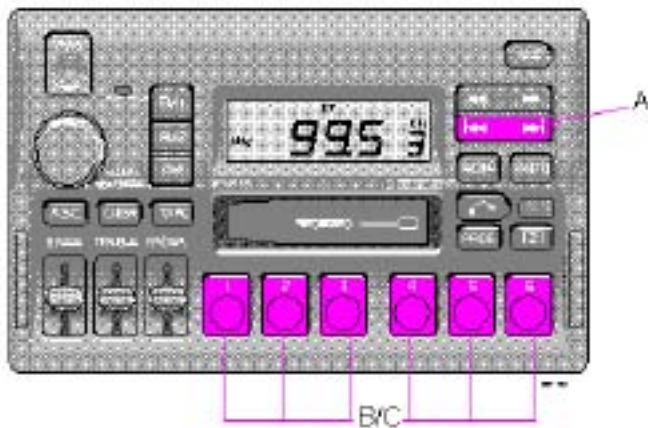

A - Seek tuning up/down

Press the left side tune button to tune to lower frequencies and the right side to tune to higher frequencies. The radio seeks the next audible station and stops there. If you wish to continue the seek tuning, press the tune button again.

B - Preset programming

1. Tune to the desired frequency.
2. Depress and hold a preset button. The audio will cut out. Keep the button depressed until the audio comes on again (approx. 2 seconds).
3. The frequency is now stored on this preset button.

C- Preset buttons

To select a pre-programmed radio frequency, depress the preset button. The set frequency will be displayed.

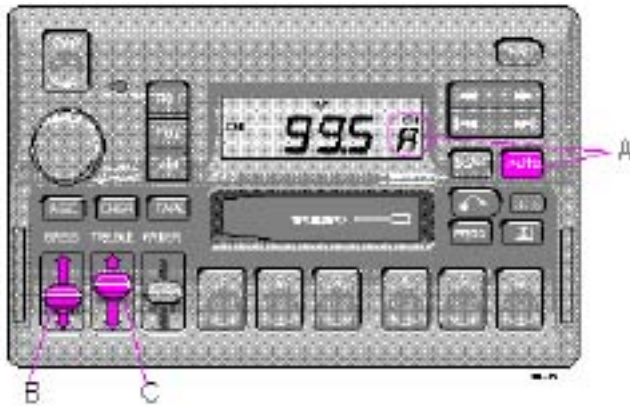

A - Automatic programming (Auto)

Please note that this function will not interfere with pre-stored stations on buttons 1-6.

This function automatically seeks and stores up to 8 strong AM or FM stations.

This is especially useful when travelling in areas where radio stations are unfamiliar.

1. Depress and hold the "AUTO" button for **at least 1 second**. A number of strong stations (max. 8) on the chosen waveband are now automatically stored in the memory.

If there are no audible stations, "- - - -" is displayed.

2. Press the "AUTO" button (**for less than 1 second**) to obtain another autostored station. A new station will be selected each time the button is pressed momentarily.

B - Bass control

Adjust the bass by sliding the control up or down (up to increase, down to decrease).

A "detent" indicates "equalized" bass.

C- Treble control

Adjust the treble by sliding the control up or down (up to increase, down to decrease).

A "detent" indicates "equalized" treble.

pg. 147 Radio SC-813

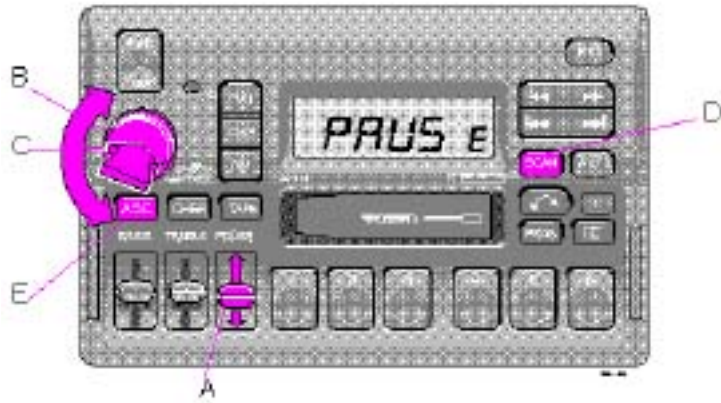

A - Fader control

Adjust front/rear speaker balance by sliding the control up or down.

(**Up** to direct more sound to the front speakers, **Down** to direct more sound to the rear speakers).

The "detent" indicates "equalized" front /rear balance position.

B - Pause function

Press the "volume" knob to temporarily mute the sound. "PAUSE" is displayed.

C- Balance control

Pull out the "volume" knob and adjust the left/right balance by turning the knob counter- clockwise or clockwise.

D- Scan

Press this button to listen to each station for five seconds. Press it again to stop scanning. "Scan" will be displayed during scanning.

E- Active sound control (ASC)

The ASC function automatically adjusts the volume level of the audio system according to driving speed. To deactivate ASC depress the "ASC" button.

To activate ASC, depress the "ASC" button until "ASC" is displayed.

pg. 148 Cassette deck

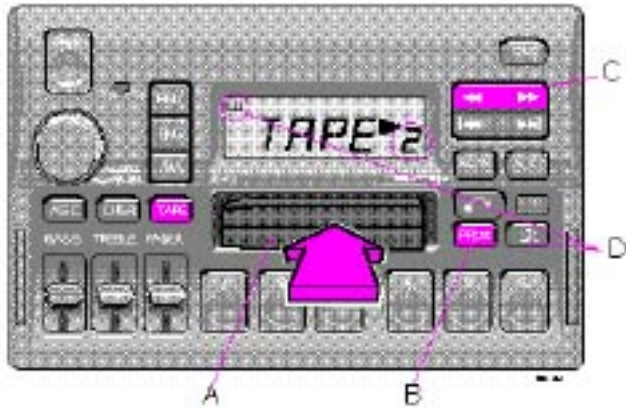

A - Cassette slot

The cassette is inserted with the open side to the right (side 1 or A of the cassette upwards).

When the cassette is inserted, the radio is disengaged and the cassette will start to play automatically. "TAPE " or "TAPE " is displayed to indicate which side of the tape is being played. When one side of the tape has been played the unit will automatically play the other side (auto-reverse). The cassette can be inserted or ejected even when the unit is switched off.

B - Reversing the tape (PROG)

Press the button to play the other side of the tape.

The side of the tape being played will be displayed.

C- Fast winding

The tape is advanced with " F.F. " and rewound with " R.W. ".

Fast winding can be stopped by pressing either the button again or the "TAPE" button.

D- Dolby B NR button

Press this button when you use tapes recorded with the Dolby B noise reduction system.

The Dolby symbol  will be indicated in the display.

pg. 149 Cassette deck



A - Next selector

Press the " " button and the tape will automatically advance to the next song.

There must be a pause of approx. 5 seconds between songs for this function to operate.

B - Previous selector

Press the " " button and the tape will automatically rewind to the previous song.

There must be a pause of approx. 5 seconds between songs for this function to operate.

C- Pause

If you press the "volume" knob the tape is stopped, the unit is silent and "PAUSE" is displayed. To restart the tape press the knob again.

D- Scan

Press this button to listen to the first five seconds of each song. Press this button or the "TAPE" button to stop scanning. During scanning "SCAN" will be displayed.

pg. 150 Cassette deck

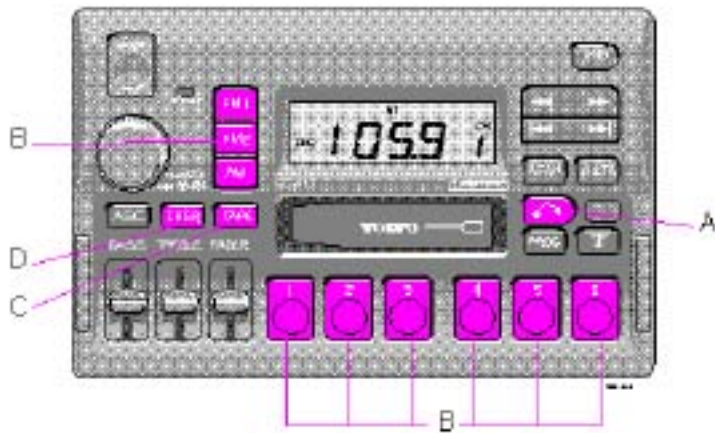

A - Cassette eject

If the button is pressed the tape will stop and the cassette will be ejected. The radio will be automatically engaged. The radio or CD changer will engage automatically (depending on which mode was activated before the tape was played).

B - To re-enter Radio mode

Push one of the waveband selector buttons

When the unit re-enters Radio mode, the cassette will not be ejected.

C- To re-enter Tape mode

If the Tape function has been disconnected and the cassette has not been ejected, the Tape mode can be re-entered by pressing the "TAPE" button.

D- To re-enter CD changer mode

If the CD changer function has been disconnected, the CD changer mode can be re-entered by pressing the "CHGR" button.

pg. 151 CD - Changer (option)

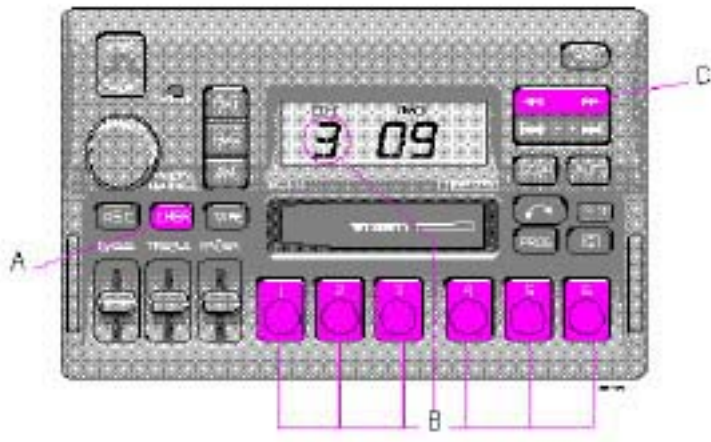

A - CD changer mode selector

Press "CHGR" to actuate the CD changer mode. The disc/track last listened to will continue to play. If the CD-changer cartridge* is empty, "---" will be displayed.

If a selected disc does not exist, the disc number and "5--" will be displayed and the next disc will be automatically selected.

B - Disc number selector

Depress one of the preset buttons (1-6) to select the disc number desired. The selected disc number and track number will be displayed.

C- Music search

Press the "◀" or "▶" button to search within a track. While the button is depressed the playing time for this track will be displayed.

*The functions pertaining to the CD-changer are only applicable if the unit has been connected to the Volvo CD-changer, which is sold separately as an accessory, or on certain models, standard on the car. If no CD-changer is connected to the unit "EEEE" will be displayed if you happen to choose CHGR mode.



A - Changing the selected track number

Press "FWD" for forward selection or "REV" for backWard selection. The chosen disc number and track number will be displayed.

B - Playing-time display

When the "CHGR" button is pressed the playing time for the current track is displayed for 5 seconds.

C- Scan

Press this button to listen to the first ten seconds of each track. Press it again to stop scanning. During scanning "SCAN" will be displayed.

pg. 153 CD - Changer (option)

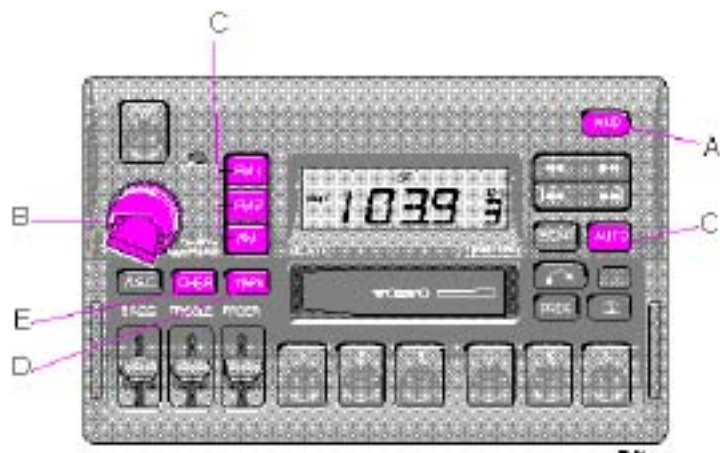

A - Random choice

Press "RND" to actuate the random mode. From a disc chosen at random, 4 tracks will be played (also

chosen at random). A new disc will then be played in the same way. "RND" will be displayed when this function is engaged.

B - Pause

If you press the "volume" knob the disc is stopped, the unit is silent and "PAUSE" is displayed. To restart the disc press the knob again.

C- To re-enter Radio mode

Push one of the waveband selector buttons.

D- To re-enter Tape mode

If a cassette is already inserted, the tape deck will re-engage if the "TAPE" button is pressed.

E- To re-enter CD changer mode

If the CD changer function has been disconnected, the CD changer mode can be re-entered by pressing the "CHGR" button.

pg. 154 Technical specifications

SC-813

Radio

System: PLL (Phase Lock Loop) system with tuned RF (Radio Frequency) front and end automatic wide band gain control.
Electronic suppression circuitry (noise killer).

This Radio is equipped with FM-Diversity.

Frequency range:

AM	530 -1710 kHz
FM	87.9 - 107.9 MHz

Sensitivity:

AM	1.1 μ V
FM	20 μ V

Stereo separation: 35 dB

Cassette deck

4track, 2 channel stereo

Full logic electronic tape transport

Tape speed: 4.76 cm/sec.

Channel separation 53 dB

Frequency range 3015000 hz

S/N (120 μ V) 56 dB without Dolby B NR

S/N (120 μ V) 66 dB with Dolby B NR

Wow and Flutter < 0.06%

Pinch off

"Dolby" and the double D symbol  are the trademarks of Dolby Laboratories Licensing Corporation. Dolby noise reduction manufactured under license from Dolby Laboratories Licensing Corporation.



[Contents](#) | [Top of Page](#)

Power output: 4 x 25 W (10% dist.)

Output impedance: 4 Ohms

System voltage: 12 Volts, negative ground

2000 VOLVO S & V70

pg. 155 Audio system SC816 (certain models)

The following pages describe the use of your SC816

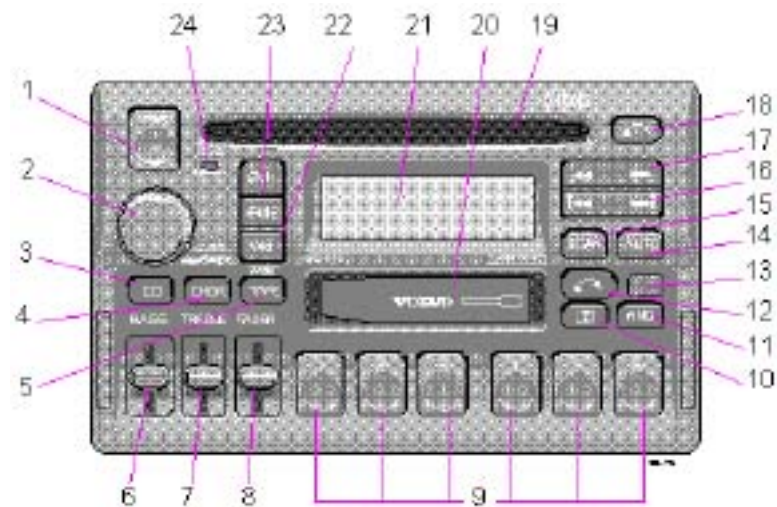

1. On/off (push)
2. · Volume (turn)
· Pause/Mute (push)
· Balance (pull)
3. CD mode selector - Active Sound Control (single)
4. CD changer selector
5. · Tape mode selector
· Tape direction selector PROG
6. Bass control
7. Treble control
8. Fader control

9. · Preset buttons
 - CD-Disc No. selector
10. Dolby B NR button
11. CD-random play
12. Cassette eject
13. Not in use
14. Auto seek memory
15. Scan
16. · Seek tuning up/down
 - **TP**-Next/Previous song
 - **CD**-Next UP/Previous DOWN track
17. · Manual tuning
 - **TP**-fast forward/Rewind
 - **CD**-Music searchUP/DOWN
18. CD eject (single)
19. CD slot
20. Cassette slot
21. Display
22. Waveband selector (AM)
23. Waveband selectors (FM)
24. · Anti-theft LED
 - Disc in LED (single)

TP = Applicable only in Tape Mode

CD = Applicable only when in CD mode and connected to a CD changer.

pg. 156 Anti-theft code



Anti-theft code

The radio features anti-theft circuitry. If the set is removed from the vehicle or if the battery power is disconnected, a special code must be entered to enable operation of the set.

Refer to the radio code card supplied with your vehicle or ask your Volvo retailer for the correct code.

When the car is parked with ignition key removed the anti-theft LED will flash.

Anti-theft LED



To enter the code

After installation or when the set has been disconnected from power, the set displays "CODE" when it is switched on.

Enter the 4-digit code using the preset buttons.

If the correct code is entered the set is ready to use.

If you enter an incorrect code you must enter the correct code again from the beginning.

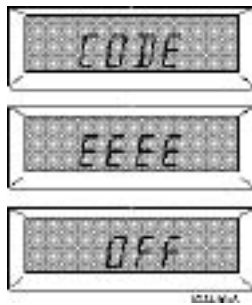

Incorrect code

If an incorrect code has been entered "EEEE" is displayed. Enter the correct code. After three unsuccessful coding attempts the set will lock and remain locked for two hours.

"OFF" is displayed.

During this waiting period:

- the battery must be connected
- the ignition key must be turned to position I
- the unit must be turned on

Make sure the headlights are turned off to help prevent battery drain (please refer to page 26 for information on turning the headlights off).

Enter the code again once this time has elapsed.

pg. 157 Radio SC-816

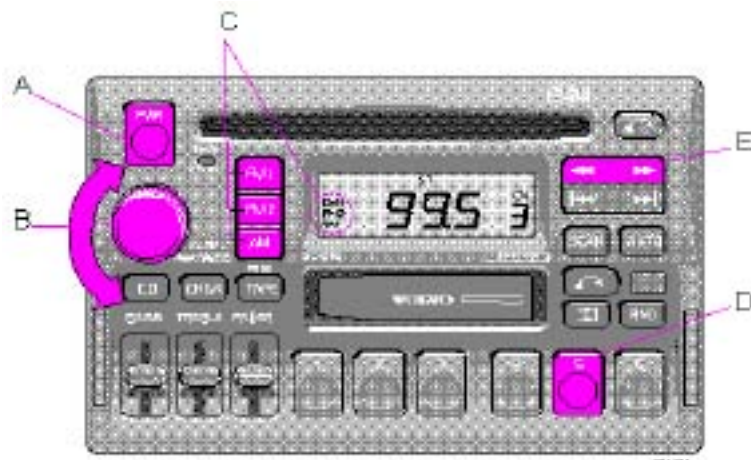

A - On/off switch

Push the button to switch on the radio. Press the button to turn the radio off.

B - Volume control

Turn the button clockwise to increase the volume. The volume control is electronic and has no end stop.

C- Waveband selector

The desired waveband is set by pressing one of the waveband selector buttons. The frequency and waveband is shown on the display.

NOTE: There are two FM wavebands and one AM waveband. This makes it possible to store 2 x 6 FM stations and 6 AM stations in the memory.

D- Setting frequency selection

The radio can be used in most parts of the world by changing the frequency selection intervals as follows:

Depress and hold preset button 5 and turn the radio ON. "USA" will flash on the display.

Each time button 5 is pressed, the frequency selection will change from "USA" to "AUS", etc. When the correct country name is displayed, wait 5 seconds and the radio will be ready for use.

E- Manual tuning

Press the left side tune button to tune to lower frequencies and the right side to tune to higher frequencies. The tuned frequency is displayed.

ST will be displayed to indicate stereo FM reception.

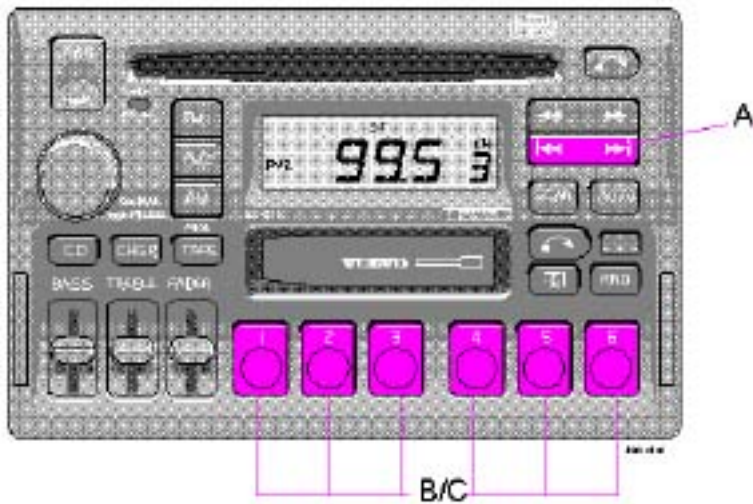

A - Seek tuning up/down

Press the left side tune button to tune to lower frequencies and the right side to tune to higher frequencies. The radio seeks the next audible station and stops there. If you wish to continue the seek tuning, press the tune button again.

B - Preset programming

1. Tune to the desired frequency.
2. Depress and hold a preset button. The audio will cut out. Keep the button depressed until the audio comes on again (approx. 2 seconds).
3. The frequency is now stored on this preset button.

C- Preset buttons

To select a pre-programmed radio frequency, depress the preset button. The set frequency will be displayed.

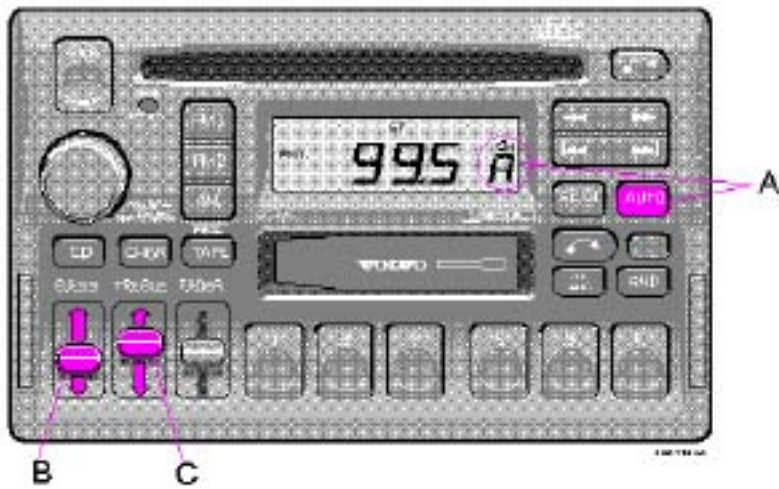

A - Automatic programming (Auto)

Please note that this function will not interfere with pre-stored stations on buttons 1-6.

This function automatically seeks and stores up to 8 strong AM or FM stations.

This is especially useful when travelling in areas where radio stations are unfamiliar.

1. Depress and hold the "AUTO" button for **at least 1 second**. A number of strong stations (max. 8) on the chosen waveband are now automatically stored in the memory.

The lowest frequency station is heard. If there are no audible stations, "- - - -" is displayed.

2. Press the "AUTO" button (**for less than 1 second**) to obtain another autostored station. A new station will be selected each time the button is pressed momentarily.

B - Bass control

Adjust the bass by sliding the control up or down (up to increase, down to decrease).

A "detent" indicates "equalized" bass.

C- Treble control

Adjust the treble by sliding the control up or down (up to increase, down to decrease).

A "detent" indicates "equalized" treble.



A - Fader control

Adjust front/rear speaker balance by sliding the control up or down.

(**Up** to direct more sound to the front speakers, **Down** to direct more sound to the rear speakers).

The "detent" indicates "equalized" front /rear balance position.

B - Pause function

Press the "volume" knob to temporarily mute the sound. "PAUSE" is displayed.

C- Balance control

Pull out the "volume" knob and adjust the left/right balance by turning the knob counter- clockwise or clockwise.

D- Scan

Press this button to listen to each station for five seconds. Press it again to stop scanning.

E- Active sound control (ASC)

The ASC function automatically adjusts the volume level of the audio system according to driving speed. To deactivate ASC depress the "CD" button until "ASC" is no longer displayed.

To activate ASC, depress the "CD" button until "ASC" is displayed (approx. 2 seconds).

pg. 161 Cassette deck

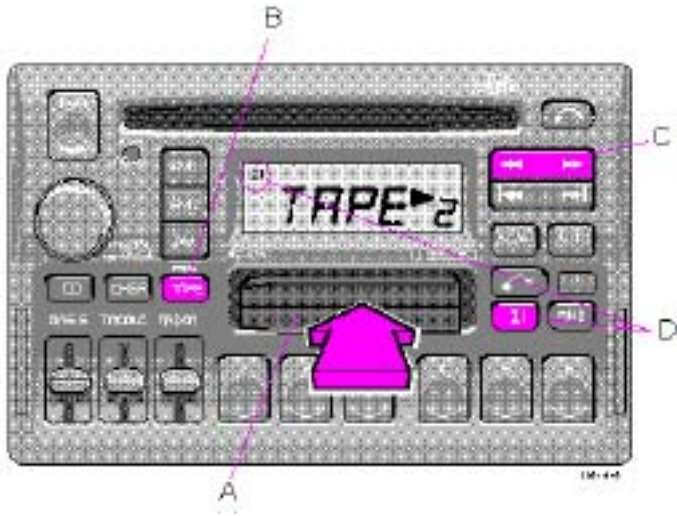

A - Cassette slot

The cassette is inserted with the open side to the right (side 1 or A of the cassette upwards).

When the cassette is inserted, the radio is disengaged and the cassette will start to play automatically. "TAPE " or "TAPE " is displayed to indicate which side of the tape is being played. When one side of the tape has been played the unit will automatically play the other side (auto-reverse). The cassette can be inserted or ejected even when the unit is switched off.

B - Reversing the tape (PROG)

Press the button to play the other side of the tape.

C- Fast winding

The tape is advanced with "FF" and rewind with "REW". "FF" will be displayed while advancing the tape. "REW" will be displayed while rewinding the tape.

Fast winding can be stopped by pressing the tuning button or the TAPE button again.

D- Dolby B NR button

Press this button when you use tapes recorded with the Dolby B noise reduction system.

The Dolby symbol  will be indicated in the display.

pg. 162 Cassette deck



A - Next selector

Press the " " button and the tape will automatically advance to the next song.

There must be a pause of approx. 5 seconds between songs for this function to operate.

B - Previous selector

Press the " " button and the tape will automatically rewind to the previous song.

There must be a pause of approx. 5 seconds between songs for this function to operate.

C- Pause

If you press the "volume" knob the tape is stopped, the unit is silent and "PAUSE" is displayed. To restart the tape press the knob again.

D- Scan

Press this button to listen to the first five seconds of each song. Press it again to stop scanning. "SCAN" will be displayed.

pg. 163 Cassette deck



A - Cassette eject

If the button is pressed the tape will stop and the cassette will be ejected. The radio will be automatically engaged. The radio, CD or CD changer will engage automatically (depending on which mode was activated before the tape was played).

B - To re-enter Radio mode

Push one of the waveband selector buttons

When the unit re-enters Radio mode, the cassette will not be ejected.

C- To re-enter Tape mode

If the Tape function has been disconnected and the cassette has not been ejected, the Tape mode can be re-entered by pressing the "TAPE" button.

D- To re-enter CD mode

If the CD function has been disconnected and the CD has not been ejected, the CD mode can be re-entered by pressing the "CD" button.

E- To re-enter CD changer mode

If the CD changer function has been disconnected, the CD changer mode can be re-entered by pressing the "CHGR" button.

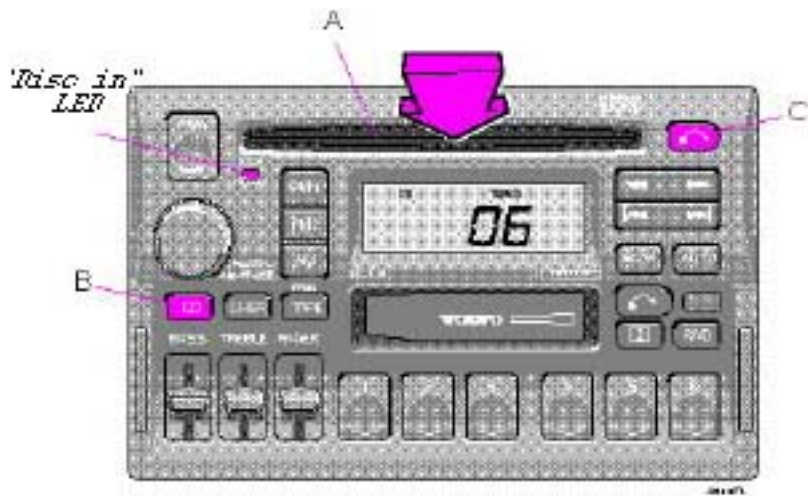

A - CD slot

With the audio system on, insert a disc into the slot with the label side up. When the CD is inserted, the radio is disengaged and the CD will start to play automatically.

The CD can be inserted or ejected even when the unit is switched off.

When the CD has been inserted into the player, the "DISC IN" light will always be ON even if the radio, tape deck or CD changer are in use.

B - CD mode selector

Press "CD" to actuate the CD mode. The track last listened to will continue to play. If the CD-player is empty, "NO CD" will be displayed.

C - CD eject

If the button is pressed the CD will stop and the disc will be ejected. The radio will be automatically engaged. The radio, tape or CD changer will engage automatically (depending on which mode was activated before the CD was played).

NOTE: If the CD eject button is pressed and the disc is not removed within 12 seconds, the disc will be drawn into the CD player again.



A - Music search

Press the " " or " " button to search within a track. While the button is depressed the playing time for this track will be displayed.

B - Changing the selected track number

Press " " for forward selection or " " for backWard selection. The disc number and the chosen track number will be displayed.

C- Playing-time display

When the "CD" button is pressed the playing time for the current track is displayed for 5 seconds.

D- Scan

Press this button to listen to the first ten seconds of each track. Press it again to stop scanning.

pg. 166 CD - Single

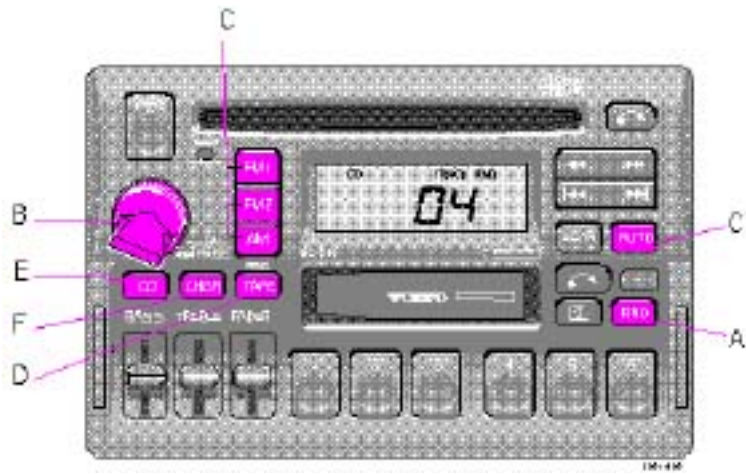

A - Random choice

Press "RND" to actuate the random mode. From a disc, tracks will be played at random. "RND" will be displayed when this function is engaged.

B - Pause

If you press the "volume" knob the disc is stopped, the unit is silent and "PAUSE" is displayed. To restart the disc press the knob again.

C- To re-enter Radio mode

Push one of the waveband selector buttons

D- To re-enter Tape mode

If a cassette is already inserted, the tape deck will re-engage if the "TAPE" button is pressed.

E- To re-enter CD mode

If the CD function has been disconnected and the CD has not been ejected, the CD mode can be re-entered by pressing the "CD" button.

F - To re-enter CD changer mode

If the CD changer function has been disconnected, the CD changer mode can be re-entered by pressing the "CHGR" button.

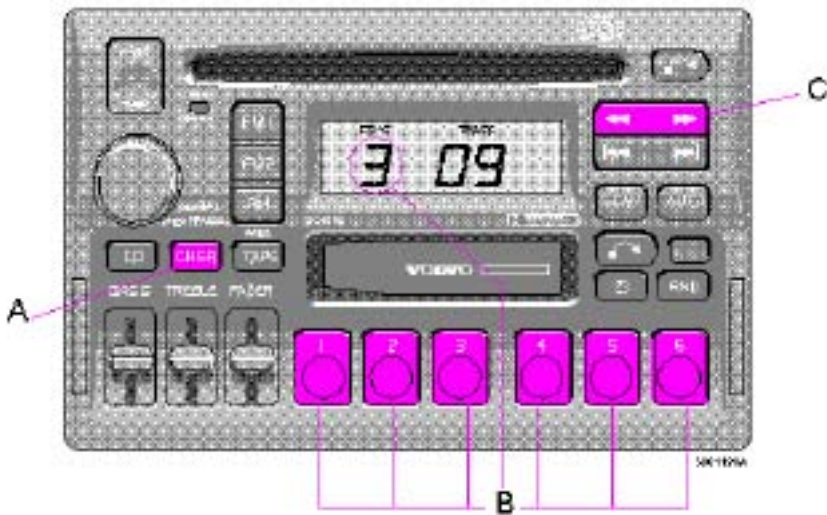

A - CD changer mode selector

Press "CHGR" to actuate the CD changer mode. The disc/track last listened to will continue to play. If the CD-changer cartridge* is empty, "0-00" will be displayed. If there is no cartridge in the changer "- -" will be displayed. If a selected disc does not exist, the disc number and "-00" will be displayed and the next disc will be automatically selected.

B - Disc number selector

Depress one of the preset buttons (1-6) to select the disc number desired. The selected disc number and track number will be displayed.

C- Music search

Press the "▬" or "▬" button to search within a track. While the button is depressed the playing time for this track will be displayed.

*The functions pertaining to the CD-changer are only applicable if the unit has been connected to the Volvo CD-changer, which is sold separately as an accessory, or on certain models, standard on the car. If no CD-changer is connected to the unit "EEEE" will be displayed if you happen to choose CHGR mode.

pg. 168 CD - Changer (option)



A - Changing the selected track number

Press " == " for forward selection or " == " for bacKWARD selection. The chosen disc number and track number will be displayed.

B - Playing-time display

When the "CHGR" button is pressed the playing time for the current track is displayed for 5 seconds.

C- Scan

Press this button to listen to the first ten seconds of each track. Press it again to stop scanning.

pg. 169 CD - Changer (option)

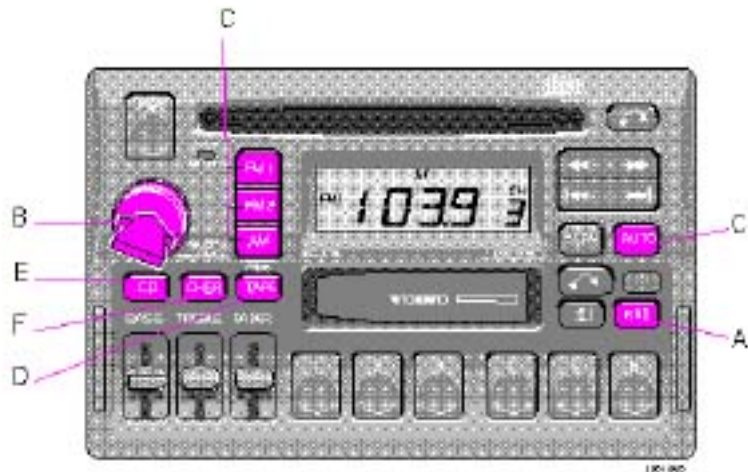

A - Random choice

Press "RND" to actuate the random mode. From a disc chosen at random, 4 tracks will be played (also

chosen at random). A new disc will then be played in the same way. "RND" will be displayed when this function is engaged.

B - Pause

If you press the "volume" knob the disc is stopped, the unit is silent and "PAUSE" is displayed. To restart the disc press the knob again.

C- To re-enter Radio mode

Push one of the waveband selector buttons.

D- To re-enter Tape mode

If a cassette is already inserted, the tape deck will re-engage if the "TAPE" button is pressed.

E- To re-enter CD mode

If the CD function has been disconnected and the CD has not been ejected, the CD mode can be re-entered by pressing the "CD" button.

F - To re-enter CD changer mode

If the CD changer function has been disconnected, the CD changer mode can be re-entered by pressing the "CHGR" button.

pg. 170 Technical specifications

SC-816

Power output:	4 x 25 W (10% dist.)
Output impedance:	4 Ohms
System voltage:	12 Volts, negative ground

Radio

System: PLL (Phase Lock Loop) system with tuned RF (Radio Frequency) front and end automatic wide band gain control.

Electronic suppression circuitry (noise killer).

The Radio is equipped with FM diversity.

Frequency range:

AM	530 - 1710 kHz
FM	87.9 - 107.9 MHz

Sensitivity:

AM	1.1 μ V
FM	20 μ V

Stereo separation: 35 dB

Cassette deck

4track, 2 channel stereo

Full logic electronic tape transport

Tape speed:	4.76 cm/sec.
Channel separation	53 dB
Frequency range	3015000 hz
S/N (120 μ V)	56 dB without Dolby B NR
S/N (120 μ V)	66 dB with Dolby B NR
Wow and Flutter	< 0.06%
Pinch off	

"Dolby" and the double D symbol  are the trademarks of Dolby Laboratories Licensing Corporation. Dolby noise reduction manufactured under license from Dolby Laboratories Licensing Corporation.



[Contents](#) | [Top of Page](#)

2000 VOLVO S & V70

pg. 171 Audio system SC-901 (certain models)

The following pages describe the function and operation of your SC-901.

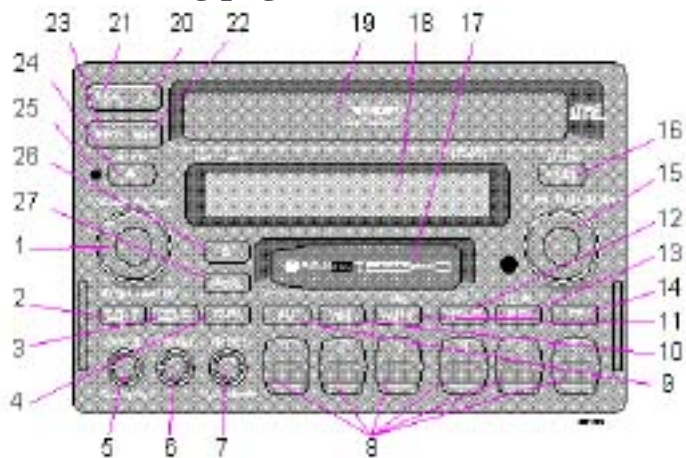

1. On/off (press)

- Volume (turn)
- Balance (pull out and turn)

2. CD player - on/off

3. CD mode selector - on/off

4. Cassette deck - on/off

5. · Bass control

- Volume control - sound effects
(pull and turn)

6. Treble control

7. · Balance control front/rear (fader)

- Volume control - center speaker
(pull and turn)

8. Preset buttons

- CD 3 disc selector 1-3
- CD 6 disc selector 1-6

9. Waveband selector (FM)

10. Waveband selector (AM)

11. · Autostore memory

- CD - random play

12. · News

- Radio text

13. · Program type selector

- Dolby B noise reduction

14. Traffic information selector

15. · Manual tuning knob

- Track selector - CD
- Scanning

16. Pro Logic Surround Sound

17. Cassette slot

18. Display

19. CD slot

20. Fast forward

- CD - forward search
- Tape - forward search
- Radio - frequency up

21. Fast rewind

- CD - bacKwards search
- Tape - bacKwards search
- Radio - frequency down

- 22. · CD - next track
 - Tape - next track
 - Radio - next station (seek up)

- 23. · CD - repeat previous track
 - Tape - repeat previous track
 - Radio - next station (seek down)

- 24. · CD - open

- 25. · Anti-Theft indicator
 - CD - warning indicator

- 26. Cassette eject

- 27. PROG - reversing the tape

pg. 172 Anti-theft code



Anti-theft code

The radio features anti-theft circuitry. If the set is removed from the vehicle or if the battery power is disconnected, a special code must be entered to enable operation of the set.

Refer to the radio code card supplied with your vehicle or ask your Volvo retailer for the correct code.

When the car is parked with the ignition key removed, the anti-theft LED will flash.

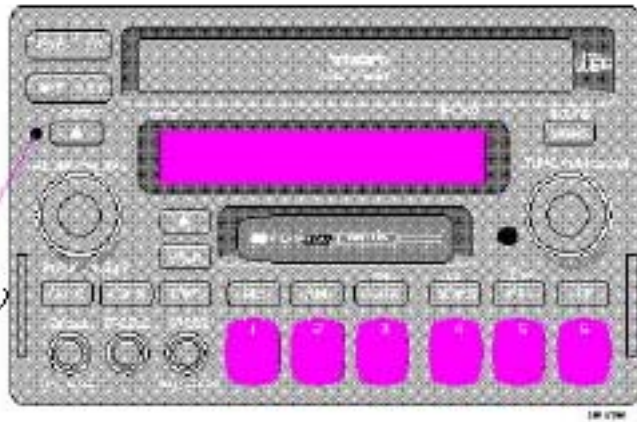

Anti-theft
light (LED)

To enter the code

After installation or when power has been disconnected, 'CODE' appears in the display when the set is switched on.

Enter the 4-digit code using the preset buttons. If the correct code is entered, the set is ready to use.

If you enter an incorrect code, you must enter the correct code again from the beginning.

Incorrect code

If an incorrect code has been entered, 'CODE Repeat' is displayed. Enter the correct code. After three unsuccessful coding attempts, the set will lock and remain locked for two hours. 'System Off' appears in the display.

During this waiting period:

- the battery must be connected
- the ignition key must be turned to position I
- the unit must be turned on

Make sure the headlights are turned off to help prevent battery drain (please refer to page 26 for information on turning the headlights off). Enter the correct code after the two hours have elapsed.

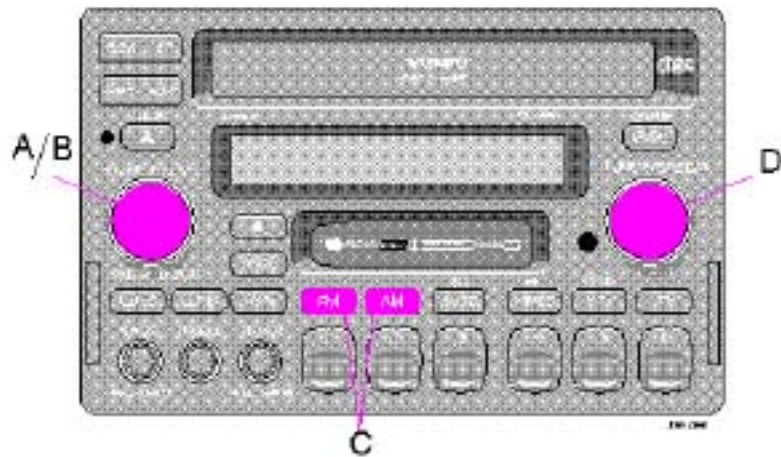

A - On/off switch

Press the button to switch the radio on/off.

B - Volume control

Turn this knob clockwise to increase the volume. The volume control is electronic and has no stop point.

C- Waveband selector

Press the "FM" or "AM" button to select the waveband you require. The name of the station and the waveband will appear in the display.

NOTE: There are three FM bands and one AM band. This allows you to store 3 x 6 FM stations and 6 AM stations. By pressing the **FM** button repeatedly you can switch between FM 1, FM 2 and FM 3.

D- Manual tuning knob

Turn this knob clockwise to select higher frequencies and counterclockwise for lower frequencies. Stored frequencies appear in the display.

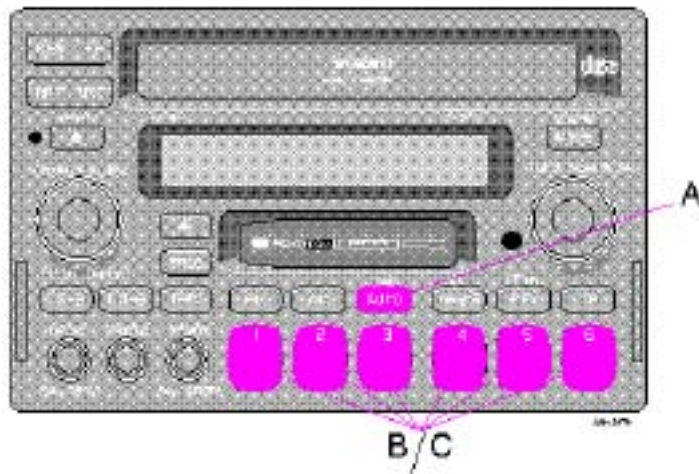

A - Automatic programming of stations

Please note that this function will not interfere with pre-stored stations on buttons 1-6.

This function automatically seeks and stores up to 10 strong AM or FM stations in a separate memory. This is especially useful when travelling in areas where radio stations are unfamiliar.

1. Press and hold the `AUTO' button for at least one second. A number of strong stations (max. 10) on the chosen waveband are now automatically stored in the memory. An `A' now appears to the right in the display. If there are no sufficiently strong signals, `No Station' is displayed.
2. Press the `AUTO' button (for less than one second) if you want to change to one of the other auto-stored stations. A new auto-stored station will be selected each time the button is pressed.

B - Preset programming

1. Tune to the desired frequency.
2. Press a preset button (the audio will cut out) and keep it pressed until the audio comes on again (approximately two seconds).
3. The frequency is now stored on this preset button.

C- Preset buttons

To select a preprogrammed radio program, press the appropriate preset button. The stored program will appear in the display.

pg. 175 Radio SC-901

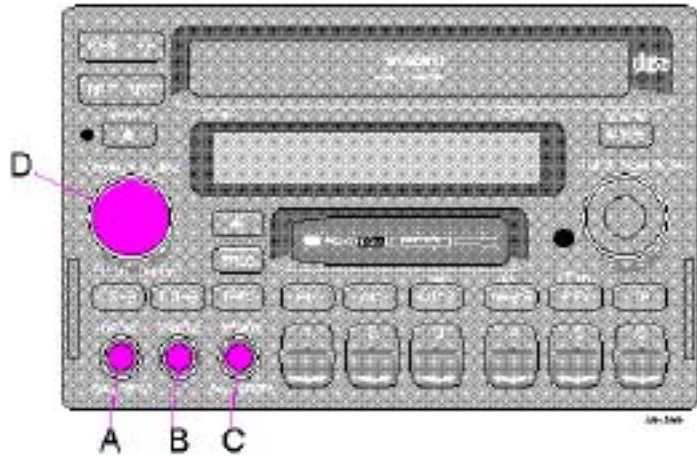
**A - Bass control**

Adjust the bass by pressing the button to extend the control and then turning it to the left (less bass) or to the right (more bass). A "detent" indicates "equalized" bass. Press the button back in when you have set the level.

B - Treble control

Adjust the treble by pressing the button to extend the control and then turning it to the left (less treble) or to the right (more treble). A "detent" indicates "equalized" treble. Press the button back in when you have set the level.

C- Fader - Balance control front/rear

Adjust front/rear speaker balance by pressing the button to extend the control and then turning it to the left (more sound from the front speakers) or to the right (more sound from the rear speakers). A "detent" indicates "equalized" balance. Press the button back in when you have set the level.

D- Balance control right/left

Pull out the `volume' button and turn clockwise/counterclockwise to adjust the balance between the right/left speakers. The balance is shown in the display.

pg. 176 RDS, Automatic tuning

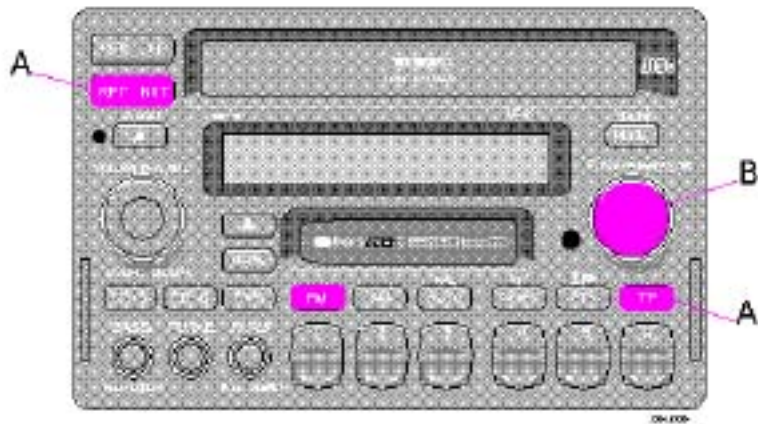

Radio Data System - RDS (also referred to as RBDS)

The SC-901 radio is equipped with an advanced system allowing information from broadcasters to be transmitted inaudibly together with the audio signal. This information is then decoded by the SC-901 and made available for several new and unique features. The RDS or Radio Data System operates in the FM band only, and the information transmitted is supplied by participating broadcasters. Volvo has no control over the accuracy of the data or information. Please refer to pages 176-181 regarding specific descriptions and operation of these functions.

Volvo was among the first to pioneer this technology throughout Europe and it is slowly making its way to North America. Coverage by local broadcasters may be limited at this time, but as the technology and benefits grow, you will find the SC-901 radio ready to take advantage of this system.

Automatic tuning

This feature may not apply in your area.

If you tune into a station using RDS, the frequency is displayed followed by the name of the station in letters. The AF function ensures that the radio automatically tunes into the most **powerful** transmitter for the selected program.

Keep the **FM** button pressed down for at least two seconds. `AF Switch OFF' appears in the display for two seconds. If you want to switch on the AF function, press the **FM** button for less than one second. `AF Switch ON' then appears in the display.

`**AF Switch ON**'- Automatic station tracking is activated

`**AF Switch OFF**'- Automatic station tracking is deactivated

A - Station seek up/down

Press the left side of the station seek button to seek for lower frequencies and the right side for higher frequencies. The radio seeks the next audible station and stops there. Press the button again to continue searching.

If the **TP** button is depressed, the station seek function will only seek stations which broadcast this particular type of program.

Press the button to switch off this function.

B - Scanning

Press this button to listen to each station for 8 seconds. If the unit is in tape or CD mode, each track will play for ten seconds.

pg. 177 Traffic Program

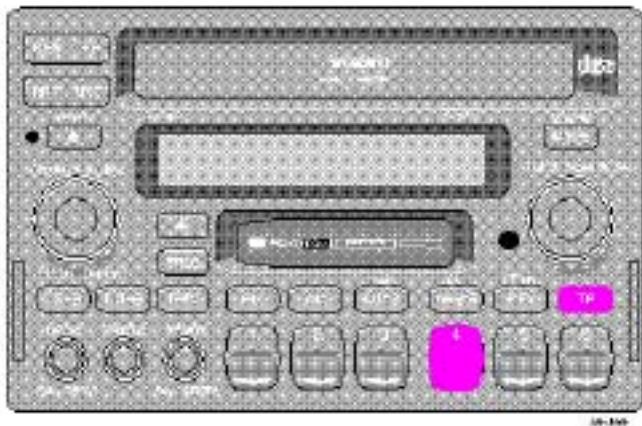

Traffic Program (TP)

This feature may not apply in your area and only functions with FM broadcasts. Please refer to the RDS information on [page 176](#).

By pressing the **TP** button, RDS stations broadcasting traffic information can be heard. `TP' is displayed when this function is switched on. If the unit is in tape or CD mode when the radio receives traffic information, the respective function will be interrupted and the announcement is received at the volume selected for traffic information.

As soon as the announcement is over, the previous volume will be restored and the tape or CD will start to play again.

- Traffic information can only be received when TP is displayed.
- If TP is flashing, it means that either no traffic information is being broadcast by the current transmitter or the signal is too weak.

After approximately 70 seconds, an audible signal will be heard, indicating that you should change to a stronger TP transmitter. To turn off this signal:

- Turn the radio off

- Press and hold down the **TP** button and turn the radio on. By pressing the **TP** button again, you can turn the TP alarm on or off.

The radio will function normally again after 5 seconds.

- Press the **TP** button again if you want to stop listening to a traffic announcement.

pg. 178 News

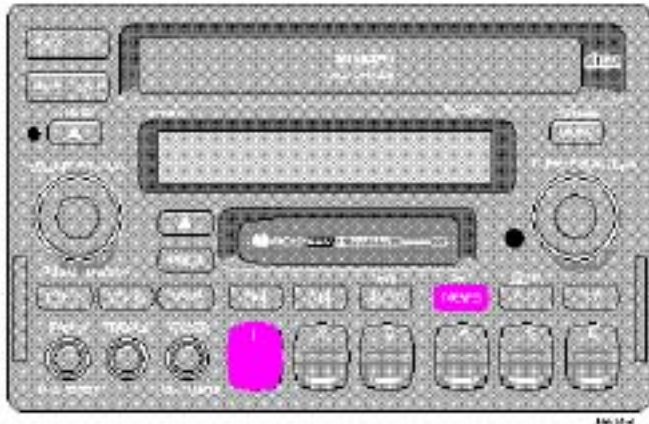

NEWS

This feature may not apply in your area and only functions with FM broadcasts. Please refer to the RDS information on [page 176](#).

Press the **NEWS** button to seek a station broadcasting news programs.

pg. 179 Program type - PTY

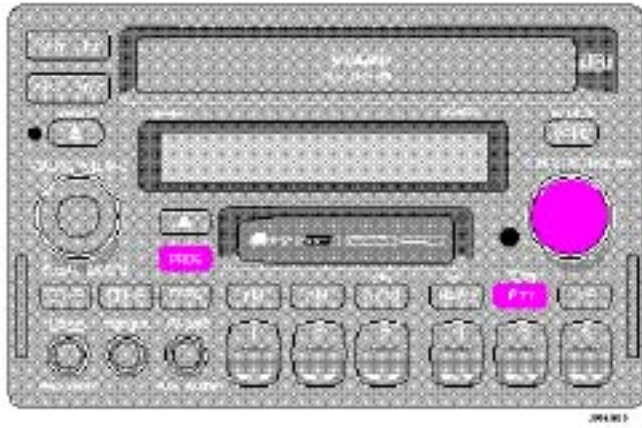

Program type

The 'PTY' function enables you to select different types of program. If you want to search for a specific program type:

1. Press the **PTY** button for less than 1 second. The program type of the currently selected radio station will be displayed.
2. By turning the manual tuning knob, it is possible to scroll through the different program types.
3. When you have found a program type you want to select, press the manual tuning knob to begin the search. During the search, the chosen program type will flash in the display.
4. If the radio finds a station of the selected program type, it will tune in this station and the station's name will appear in the display. If no station with the selected program type is found, 'No PTY' will appear in the display for five seconds and the radio will revert to the previous station.

For general information on RDS functions, please refer to [page 176](#).

pg. 180 PTY preset buttons



PTY preset buttons

Program types are factory-preset as follows:

Button 1 - Top 40

Button 2 - Classical

Button 3 - News

Button 4 - Rock

Button 5 - R&B

Button 6 - Country

These settings can be reprogrammed according to your preferences. To change the default settings:

1. Press the **PTY** button for less than 1 second to enter the PTY preset programming mode.
2. Turn the manual tuning knob to display different program types.
3. Press one of the preset buttons for at least 2 seconds to store your choice of program type on that button.

Using the PTY preset buttons

Press one of the preset buttons to select a program type. The program type stored on that button will be

displayed and a station broadcasting that type of program will be selected. Press the same button again to select a new station broadcasting the same type of program.

For general information on RDS functions, please refer to [page 176](#).

pg. 181 Volume setting, Radio text

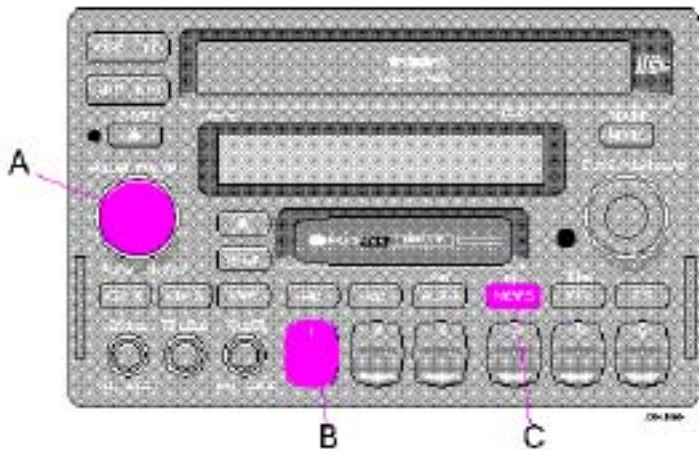

A - Volume for traffic information

If you change the volume during a traffic announcement, this volume setting will be stored automatically and used for future traffic information.

B - Automatic volume control

The Auto Volume function adjusts both the volume and frequency response according to vehicle speed.

To enable/disable (switch on or off) this function:

- Hold down **preset button 1** while switching on the radio. The current setting (ON or OFF) will be displayed.
- Press preset button 1 to toggle between ON and OFF. After five seconds, the display will return to normal and your selection (ON or OFF) will be stored.

C - Radio Text (RT)

Certain RDS stations broadcast general information on programs, music, weather, etc. in text form.

This information can be displayed by pressing the **NEWS** button for approximately 2 seconds. If no text information is available, "No radio text" will be displayed.

WARNING!

The Radio Text function should not be used by the driver while the car is in motion as this could create a traffic hazard.

For general information on RDS functions, please refer to [page 176](#).

pg. 182 Cassette deck

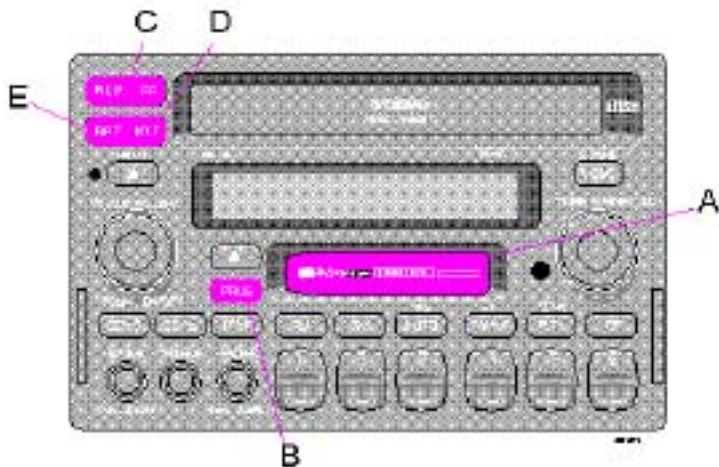
**A - Cassette slot**

Insert the cassette with the open side to the right (side 1 or A upwards). When the cassette is inserted, the radio is automatically switched off and the cassette will start to play. `Tape side A' or `Tape side B' will appear in the display to indicate which side of the tape is being played. When one side of the tape has been played, the unit will automatically play the other side (auto-reverse). The cassette can be ejected up to five minutes after the key has been taken out of the ignition.

B - Reversing the tape (PROG)

Press this button if you want to play the other side of the tape. The side of the tape being played will be displayed.

C- Fast winding

The tape is advanced with `FF' and rewind with `REW'. `FF' (fast forward) or `REW' (rewind) appear in the display when fast winding. Fast winding can be stopped by pressing the button again.

D- Next track

If you press the `NXT' button, the tape will automatically advance to the next track. There must be a gap (no audio sound) of approx. 5 seconds between songs for this function to operate.

E- Previous track

If you press the `RPT' button, the tape will automatically rewind to the previous track. There must be a gap (no audio sound) of approx. 5 seconds between songs for this function to operate.

`NXT' and `RPT' flash when the tape is either fast forwarding or rewinding.

NOTE: This radio is equipped with background FF/REW and NXT/RPT functions. This means that you can listen to the radio or a CD by selecting either of these modes while a tape is being wound.

pg. 183 Cassette deck

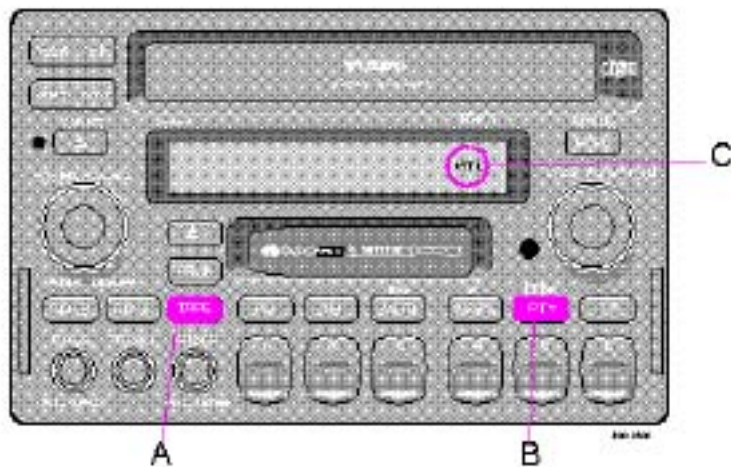

A - Pause

If you press the `TAPE' button, the tape will stop, the sound will cut off and `PAUSE' will appear in the display. Press the `TAPE' button to restart the tape.

B - Dolby B noise reduction

Press this button if you are playing a tape which has been recorded with the Dolby B noise reduction system. The Dolby symbol  appears in the display.

C- Metal tapes

If you are playing a metal tape (CrO₂) 'MTL' appears in the display.

pg. 184 Cassette deck

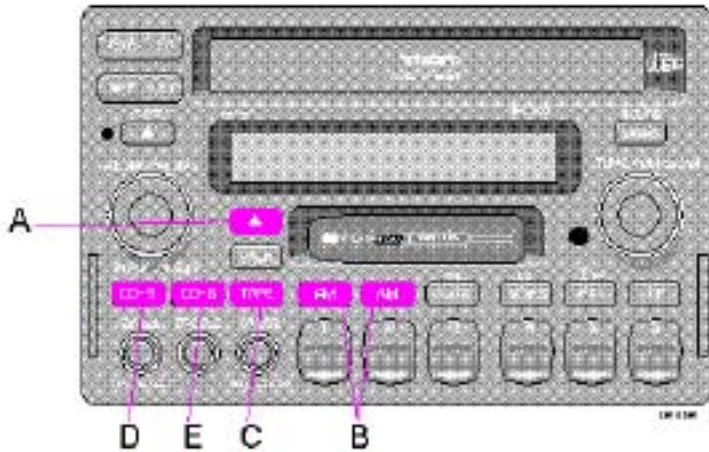

A - Cassette eject

If you press this button, the tape will stop and the cassette will be ejected. The radio, CD 3 player or CD 6 changer will be automatically switched on depending on which mode was used before the tape was played.

B - To return to the radio mode

Press the **FM**, **AM** or **AUTO** button to return to the radio mode. The radio will then be switched on without the cassette being ejected.

C- To return to the tape mode

If the cassette deck has been switched off, but the cassette has not been ejected, you can return to tape mode by pressing the '**TAPE**' button.

D- To return to the CD 3 mode

If the CD player has been switched off, but the cartridge has not been ejected, you can return to the CD 3 mode by pressing the **CD 3** button

E- To return to the CD 6 changer mode

If the CD 6 changer has been switched off, you can return to the CD 6 changer mode by pressing the **CD**

6 button.

pg. 185 CD 3 player

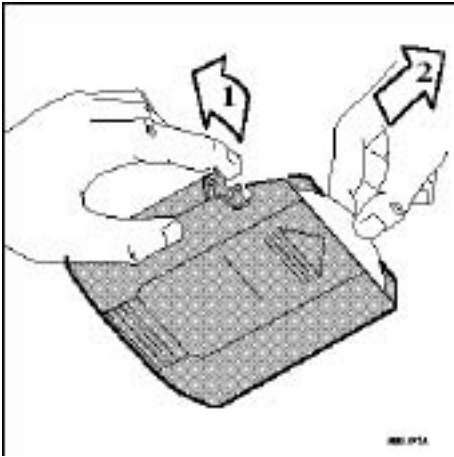

A - CD 3-slot

When you insert a cartridge, the unit will automatically switch modes and the CD 3 will start playing. A cartridge can be inserted even if the unit is switched off. **To operate:**

- Insert the discs into the cartridge, label side up.
- Insert the cartridge in the CD 3 slot, in the direction indicated by the arrow on the top side of the cartridge.
- Eject the cartridge by pressing button C.
- Remove the discs from the cartridge by pulling the lock tab for the disc you wish to remove (1). Carefully pull the disc out of the cartridge (2).

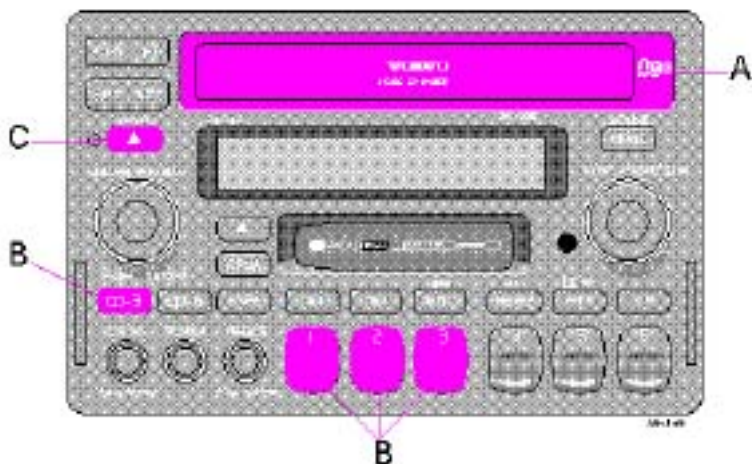

B - CD 3 player mode - on

Press the **CD 3** button to activate the CD player. The last track to be played will start playing. If there is no disc in the cartridge, the cartridge will automatically be ejected. Choose disc 1, 2 or 3 with the preselect buttons 1-3.

C- CD 3 eject

If you press this button, the CD 3 player will stop and the cartridge will be ejected. The radio, cassette deck or CD 6 changer will automatically be switched back on, depending on which function was used last.

NOTE: Do not pull the cartridge while it is in operation, as this may damage the mechanism.

pg. 186 CD 3 player

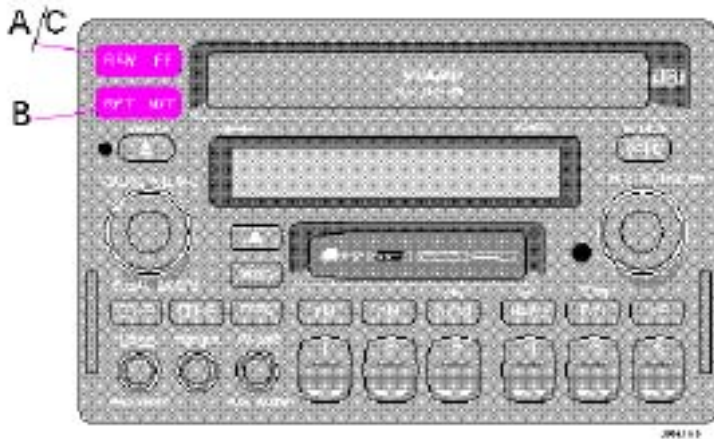

A - Music search

Press the **`FF'** or **`REW'** buttons to search within a track. While the button is pressed, the playing time for this track is displayed.

B - Changing tracks

Press **`NXT'** to move forward to the next track, **`RPT'** to repeat the previous track or turn the manual tuning knob. The selected disc number and track number will appear in the display.

C- Playing-time display

When the **`FF'** or **`REW'** buttons are pressed, the playing time for the current track is displayed for 5 seconds.

pg. 187 CD 3 player

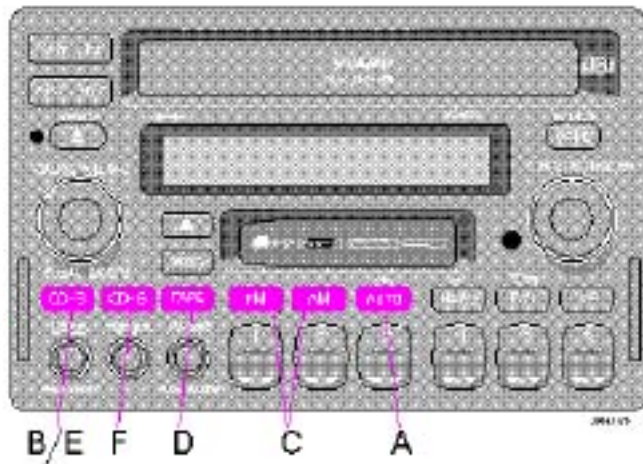
**A - Random choice**

Press **`RND'** to activate the random function. The unit will play the tracks on the disc in a random* order. **`RND'** (random) appears in the display while the function is on.

* The random function may cause a disc to be played more than once before playing through all discs.

B - Pause

If you press the **CD 3** button, the CD 3 player stops, the sound is switched off and **`Pause'** appears in the display. Press the CD 3 button again to restart the CD 3 player.

C- To return to the radio mode

Press the **FM** or the **AM** button.

D- To return to the tape mode

If a cassette is already inserted, you can return to tape mode by pressing the **`TAPE'** button.

E- To return to the CD 3 mode

If the CD 3 player has been switched off but the cartridge has not been ejected, you can return to the CD 3 mode by pressing the **CD 3** button.

F - To return to the CD 6 changer mode

If the CD 6 changer has been switched off, you can return to the CD changer mode by pressing the **CD 6** button.

pg. 188 CD 6 changer (option)

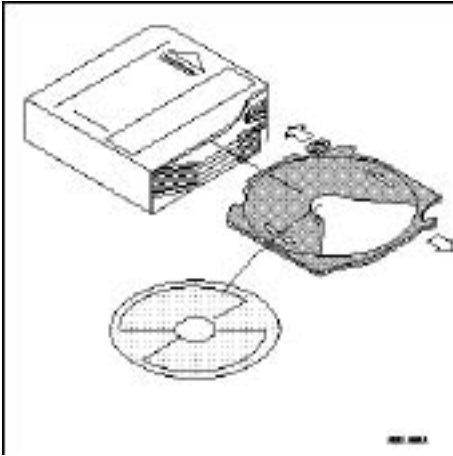

CD 6 changer

The CD 6 changer, which is available separately, is loaded with a cartridge which can accommodate 6 discs. If no CD 6 changer is connected, pressing the **CD 6** button will have no effect.

To operate:

- Slide the lid on the CD changer forward and press the eject button to remove the cartridge.
- Pull out the tray and place the disc on it, label up. Insert the tray into the cartridge.
- Insert the cartridge in the CD changer in the direction indicated by the arrow on the top side of the cartridge, and close the cover.
- Remove the discs from the cartridge by pulling out the trays.

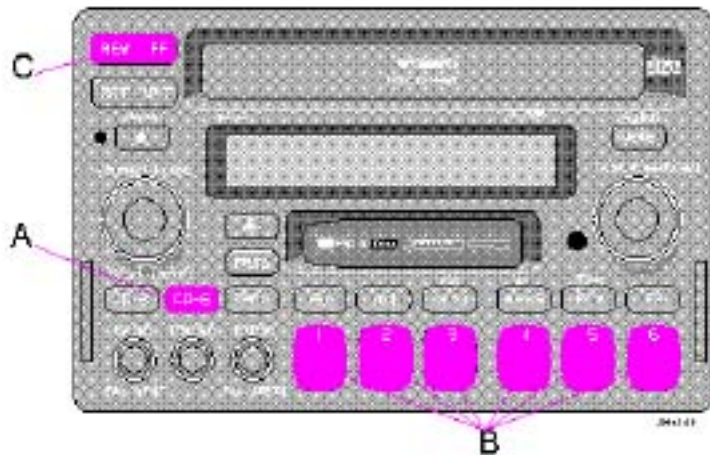

A - CD 6 changer - on

Press the `CD 6' button to activate the CD 6 mode. The CD 6 changer will start playing the last disc and track to be played. If the CD 6 changer cartridge is empty, `No Disc' will appear in the display. If a selected disc does not exist, the disc number and `CD X-00' (X is the disc number) will appear in the display, and the next disc will automatically be selected. If there is no cartridge in the CD 6 changer, `No Magazine' will appear in the display.

B - Disc number selector

Press one of the preselect buttons (1-6) to select the disc number required.

The selected disc number and track number will be displayed.

C- Music search

Press the `FF' or `REW' buttons to search within a track. While the button is pressed, the playing time for this track is displayed.

pg. 189 CD 6 changer (option)



A - Changing the selected track number

Press `NXT' to move forward to the next track, `RPT' to repeat the previous track or turn the manual tuning knob. The selected disc number and track number will be displayed.

B - Playing-time display

When the `FF' or `REW' buttons are pressed, the playing time for the current track is displayed for 5 seconds.

pg. 190 CD 6 changer (option)

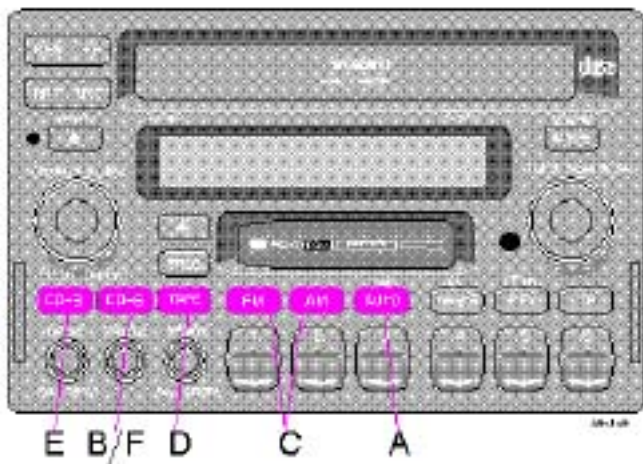

A - Random choice

Press `RND' to activate the random function. Randomly selected tracks will play from randomly

selected discs. `RND' (random) appears in the display while the function is on.

B - Pause

If you press the CD 6 button, the sound is switched off and `Pause' appears in the display. Press the CD 6 button again to restart the CD 6 changer.

C- To return to the radio mode

Press the **FM** or the **AM** button.

D- To return to the tape mode

If a cassette is already inserted, you can return to tape mode by pressing the `**TAPE**' button.

E- To return to the CD 3 mode

If the CD 3 player has been switched off but the cartridge has not been ejected, you can return to the CD 3 mode by pressing the CD 3 button.

F - To return to the CD 6 changer mode

If the CD 6 changer has been switched off, you can return to the CD 6 changer mode by pressing the CD 6 button.

pg. 191 Dolby Pro Logic Surround Sound (option)

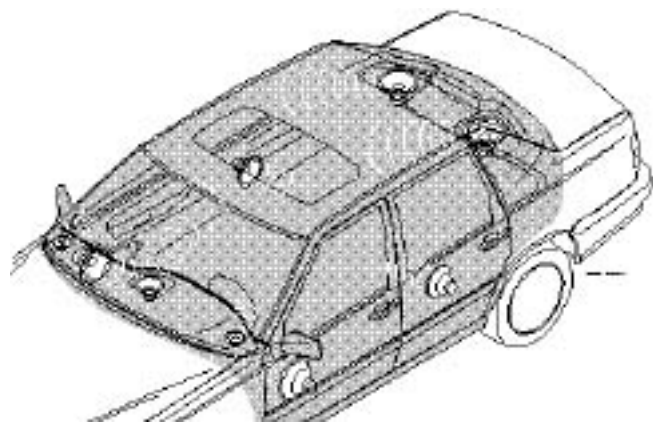

Dolby Pro Logic Surround Sound

During CD playback, Dolby Pro Logic Surround Sound, together with the speaker in the center of the

dashboard, offers you very clear and realistic sound.

Through a connection to a special decoder (optional on certain models), as well as a center speaker (option), the normal left-right stereo channels are divided into left-center-right. In addition, "surround" sound can be created from the car's rear speakers.

Most modern discs are recorded so that vocals are heard in the center foreground, while the orchestra is heard across the entire left-right range, as well as from behind.

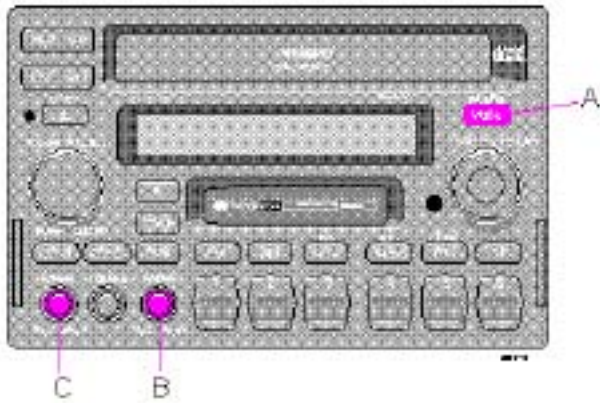

A - Engaging Surround Sound

During CD playback, press the `MODE' button to engage the center speaker and the surround unit. The mode selected will be displayed.

"3 CH" = center speaker also engaged.

"Dolby Pro Logic" = Dolby Pro Logic engaged with surround effect from rear speakers *.

B - Center speaker volume control

First press the button in slightly to pop it out, then pull the button out completely and turn it to adjust the volume of the center speaker.

C - Effect channel volume*

First press the button in slightly to pop it out, then pull the button out completely and turn it to adjust the volume level from the rear speakers (Dolby Pro Logic only).

* The "Effect" button will work only during CD playback in Dolby mode.

* SC-900 - will not function in AM or FM Radio mode.

SC-901 - will not function in AM Radio mode.

pg. 192 Other settings

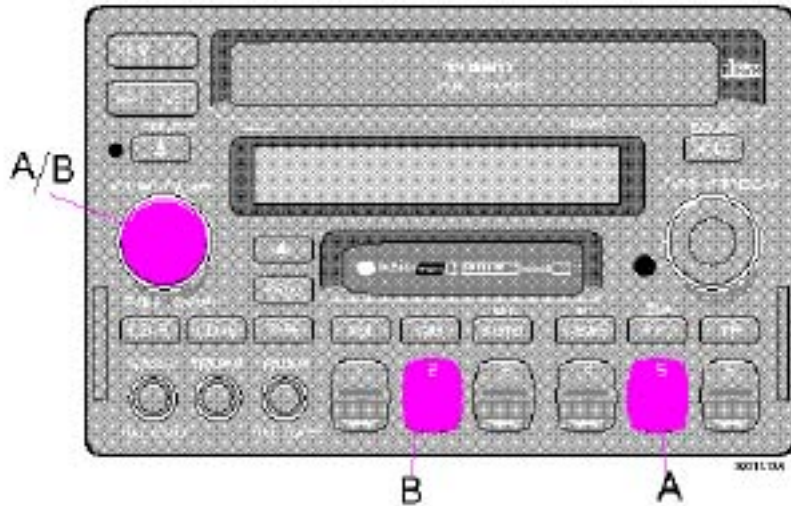

A - Settings for individual markets

Settings for individual markets are usually adjusted in the factory or at the retailer. If you need to change this setting: switch off the radio; hold down preset button 5 (A); switch on the radio (A) and press preset button 5 again until the relevant market (US, AUS or EU) appears.

B - Setting the internal equalizer

To select the frequency correction:

- Switch off the radio.
- Hold down preset button 2 (B).
- Switch the radio on again.
- Press button 2 until the desired curve appears : S70-V70-S40-V40-Custom.

Setting the custom equalizer (Custom EQ) - SC-901 only

· Select "Custom EQ" by switching off the radio, holding down preset button 2 and switching the radio again. Select "Custom" (see point B).

- Press Scan.
- Press preset button 1-5 within 5 seconds:
Preset button 1 = set bass (60 Hz)

Preset button 2 = set mid-range bass (200 Hz)

Preset button 3 = set lower mid-range (800 Hz)

Preset button 4 = set upper mid-range (3 kHz)

Preset button 5 = set treble (12 kHz)

· Adjust the setting by turning the Tune knob clockwise (increase) or counterclockwise (decrease).

The change can be seen in the display, as well as heard.

· Use preset button 6 to adjust the settings of the front or rear speaker.

F = Front

R = Rear

Please note that the equalizer curves can be adjusted separately for the front and rear speakers.

· When you are satisfied with the adjustments you have made, press Scan again to store the settings.

· Press Scan once again to exit the settings mode.

· To select "Custom EQ", press the Volume knob.

pg. 193 Technical specifications

SC-901

Output (center speaker):	1 x 25 W
Output (supplementary amplifier *):	4 x 50 W, 10% dist
Frequency range:	30 - 20,000 Hz
S/N:	min.74 dB rel. to 1 W
Output impedance:	4 Ohms
System voltage:	12 V, negative ground

Radio

Volvo's SC-901 stereo system contains a microprocessor-controlled radio receiver with PLL (Phase Lock Loop), designed for RDS (Radio Data System). The SC-901 must be connected to a separate power amplifier.

Frequency range:

AM	530 - 1710 kHz
FM	87.9 - 107.9 MHz

Sensitivity:

AM	2.2 μ V
FM	1.1 μ V

Stereo separation: 35 dB

Cassette deck

4-track, 2-channel stereo

Full logic electronic tape transport

Tape speed: 4.76 cm/sec.

Channel separation: 40 dB

Frequency range: 30 - 15,000 Hz

S/N (120 µV): 50 dB

Wow and Flutter: < 0.07%

Pinch-off

* Optional

Alert

'Alert!' will be displayed when emergency information is broadcast. This function is used to warn drivers in the event of a serious accident or disaster situation.

'Dolby' and the  symbol are the trademarks of Dolby Laboratories Licensing Corporation. The Dolby noise reduction system is manufactured under licence from Dolby Laboratories Licensing Corporation.

Dolby Pro Logic is the trademark of Dolby Laboratories Licensing Corporation. The Dolby Pro Logic Surround System is manufactured under licence from Dolby Laboratories Licensing Corporation.

CAUTION: The optional supplementary amplifier may be mounted under the front passenger's seat. If the floor of the car has become soaked for any reason, do not turn on the radio. This would cause damage to the amplifier. Contact a Volvo retailer.



[Contents](#) | [Top of Page](#)

2000 VOLVO S & V70

pg. 194 Audio systems, general information

Cassettes

- Store cassettes in their cases.
- Do not touch the tape surface with your fingers.
- Tapes should not be exposed to direct sunlight or extreme temperatures.
- Keep tapes away from oil, grease and other contaminants.
- For optimal tape deck performance Volvo does not recommend the use of C-120 tapes.
- Take up slack using a pen or a pencil before inserting a cassette in the cassette slot.

Cassette cleaning

We recommend the use of the Volvo Cleaning Cassette available as a genuine Volvo accessory. Regular use improves sound quality, cleans vital parts and prevents tape tangle.

Compact disc care

- Before using a new disc for the first time, remove any burrs in the center/outer edge by running the stem of a pen or similar object around the hole/edge of the disc.
- Use high quality discs only.
- Keep the discs clean. Wipe them with a soft, clean, lint-free cloth, working from the center outwards. If necessary, dampen the cloth with a neutral soap solution. Dry thoroughly before using.
- Never use cleaning spray or antistatic liquid. Use only cleaners specifically made for CD's.
- Use discs of the correct size only (3.5" discs should never be used).
- Do not put tape or labels on the disc itself.
- Volvo does not recommend the use of plastic outer rings on the disc.
- Condensation may occur on discs/optical components of the changer in cold winter weather. The disc can be dried with a clean, lint-free cloth. Optical components in the CD changer may, however, take up to one hour to dry off.
- Never attempt to play a disc which is damaged in any way.
- When not in use, the discs should be stored in their covers. Avoid storing discs in excessive heat, direct sunlight or dusty locations.

pg. 195 Audio systems, general information

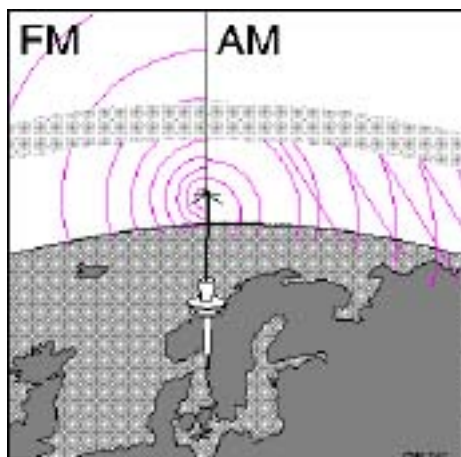

Sending signals

The FM waves do not follow the earth's surface nor do they bounce off the atmosphere. For this reason their range is limited. The AM waves follow the earth's surface and reflect against the atmosphere, giving them a wide range.

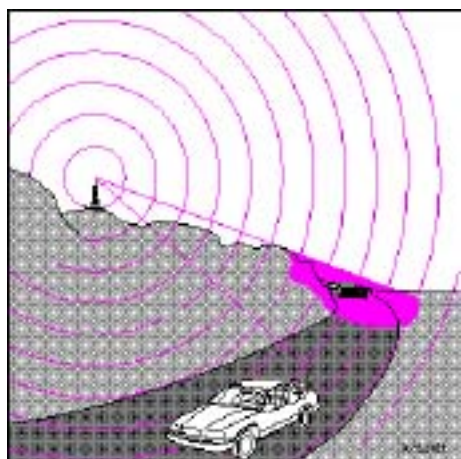

Weak reception (fading)

Because of the limited range of the FM senders and the fact that these waves are very reflective, this problem usually occurs with FM reception. If the sender is blocked by buildings or mountains, static can result.

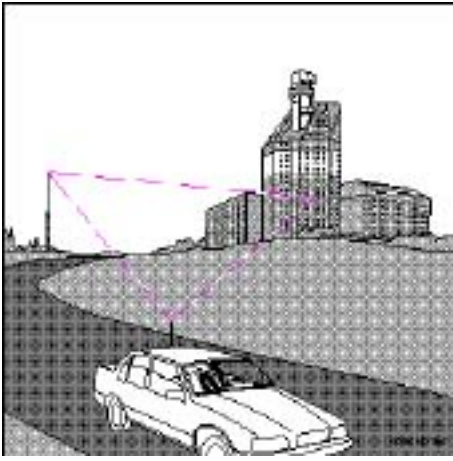

Static

The reason why FM but not AM is audible in covered parking areas, under bridges, etc, is that FM signals reflect against solid objects such as buildings. Because these waves are very reflective, static can result. This static is the result of the reflected signal and the direct signal reaching your antenna at slightly different times causing a cancellation of all signals. This problem occurs largely in built-up areas. Your car is equipped with a dual antenna system which helps alleviate this problem.

pg. 196 Audio systems, general information

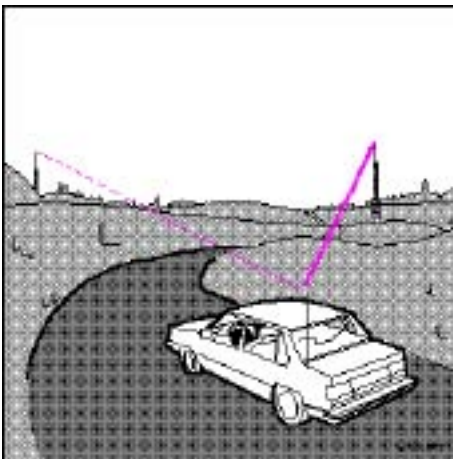

Cross modulation

If you listen to a weak station in the vicinity of a stronger one, both stations may be received simultaneously. If the car is moved a short distance, the weaker signal may be heard more clearly.

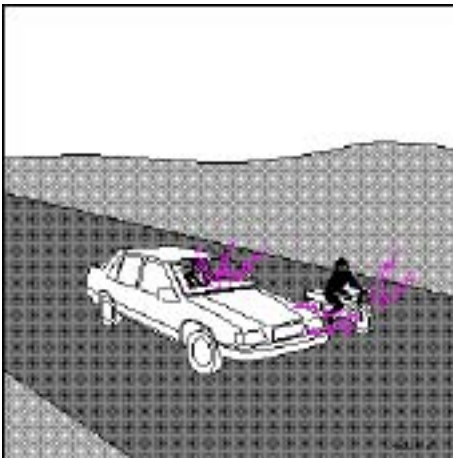

FM - reasons for distortion

FM is affected by the electrical systems of nearby vehicles, especially those without suppression. The distortion increases if the station is weak or poorly set.

The FM reception is not as sensitive to electrical disturbance as AM.

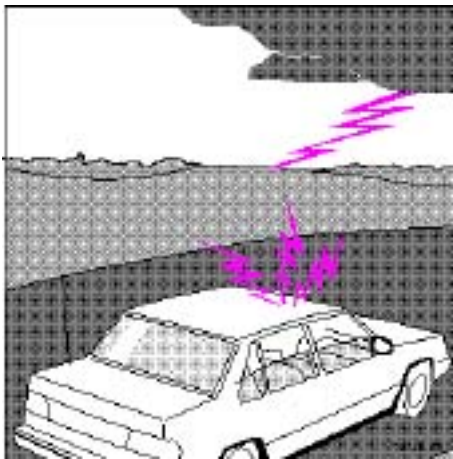

AM - reasons for distortion

AM reception is sensitive to electrical disturbances such as power lines, lightning, etc.

pg. 197 Audio systems, general information

FM stereo reception

Stereo reception places very high demands on the signal quality which means the type of distortions previously mentioned become even more obvious. The signal strength needs to be stronger for good stereo reception and this limits the effective range of the sender.

We hope that this information proves to be useful and provides you with a better understanding of the problems related to car radio reception.

Reception conditions are not always optimum and this is, of course, beyond our control. However, we have endeavoured to make the Volvo Audio System of a quality that will enable you to enjoy the best possible reception no matter what the reception conditions may be.

Radio antennas (sedans)

NOTE: Always lower the antenna when using an automatic car wash or entering a garage.

The antenna should be cleaned at least every 15,000 miles (24,000 km) or more frequently if needed. Use WD40 for cleaning.

Spray the antenna with WD40 and wipe it clean and dry with a rag. Spray it again. Lower and raise the antenna. Wipe it clean and dry again. Lower and raise the antenna 4-6 times.

Make sure it is dry and free from dirt or lubricating oil.

Radio antennas (wagons)

The radio antennas (2) are built into both side windows of the cargo area. These antennas also have factory installed antenna boosters.

NOTE: The antennas will not function without these boosters.

Place objects in the cargo area so that the antenna wires on the inside of the window will not be damaged. When cleaning the windows be careful that the wires are not scratched by rings, etc. If they are damaged, radio reception will be impaired.

Diversity antenna (dual antenna system)

Certain models are equipped with the optional Diversity dual antenna system. Two antennas are connected to the radio through two separate sockets, allowing for better reception and reducing the effects of static or multipath distortion of FM reception.



2000 VOLVO S & V70

HomeLink® Universal Transceiver (option)

pg. 198 HomeLink® Universal Transceiver (option)

Indicator light

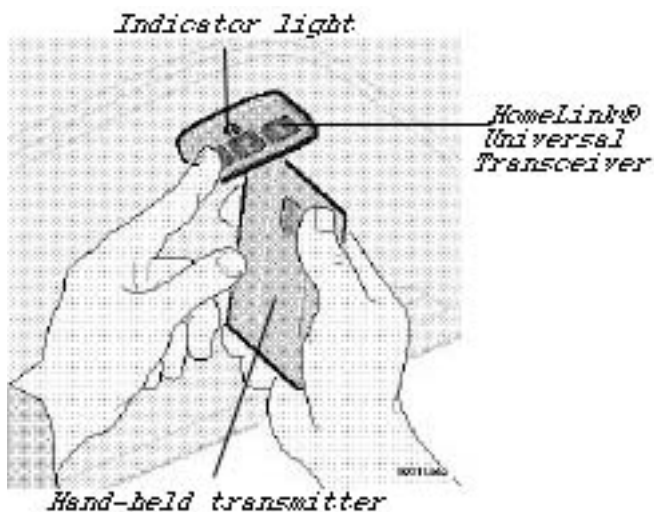

HomeLink® Universal Transceiver

This transceiver allows you to replace 3 hand-held transmitters with a single built-in device which can be installed in your car on a sun visor or overhead console. This feature "learns" the radio frequency codes of most current transmitters to operate garage doors, driveway gates, security lighting and home security systems. This transceiver is powered by your car's electrical system.

NOTE: As a security precaution, the HomeLink® Universal Transceiver is designed to **not** function if the car has been locked from the *outside*.

Programming the transceiver

1. Begin by erasing all 3 factory default channels by holding down the two *outside* buttons (buttons 1 and 3 in the illustration above) on the HomeLink® Universal Transceiver until the indicator light on the transceiver begins to flash, after approximately 20 seconds. Release the buttons.

2. Hold the end of your hand-held transmitter 2 to 5 in. (5 to 12 cm) away from the HomeLink® surface, keeping the indicator light in view. For placement questions, please contact HomeLink® at 1-800-355-3515 (Internet: www.HomeLink.jci.com).

3. Using both hands, simultaneously push the hand-held transmitter button *and* the HomeLink® button to be programmed. **Do not release the buttons until this step has been completed.** The HomeLink® indicator light will begin to flash, first slowly, then rapidly. When the indicator light flashes rapidly (indicating that the HomeLink® button has been successfully programmed), both buttons may be released.

The remaining two HomeLink® buttons can be programmed in the same way.

If, after several attempts, you do not successfully program the HomeLink® Universal Transceiver to learn the signal of the hand-held transmitter, refer to the section "Programming rolling codes" or call the toll-free customer assistance number: 1-800-355-3515 (Internet: www.HomeLink.jci.com).

WARNING!

- If you use the HomeLink® Universal Transceiver to open a garage door or gate, be sure that no one is near the gate or door while it is in motion.
- Do not use the HomeLink® Universal Transceiver with any garage door opener that lacks safety "stop" and "reverse" features as required by federal safety standards. (This includes any garage door opener model manufactured before April 1, 1982). A garage door opener which cannot "detect" an object, signalling the door to "stop" and "reverse" does not meet current federal safety standards. Using a garage door opener without these features increases the risk of serious injury or death. For more information on this matter, call toll-free 1-800-355-3515 (Internet: www.HomeLink.jci.com).

pg. 199 HomeLink® Universal Transceiver (option)

NOTE - Canadian residents:

During programming, your hand-held transmitter may automatically stop transmitting. To train your hand-held transmitter, continue to hold the HomeLink® button (see steps 2, 3 under "Programming the transceiver") while you press and repress ("cycle") your hand-held transmitter button *every two seconds* until the frequency signal has been learned. The HomeLink® indicator light will flash slowly and then rapidly to indicate that the HomeLink® button has been successfully programmed.

Programming rolling codes

Determine, in one of the following ways, if your garage door uses a rolling code system and is manufactured after 1996:

- Refer to the garage door opener's owner's manual for verification.
- The hand-held transmitter appears to program the HomeLink® Universal Transceiver but the transceiver does not activate the garage door.
- Press the programmed HomeLink® button. The garage door opener has the rolling code feature if the HomeLink® indicator light flashes rapidly and then glows steadily after approximately 2 seconds.

To train a garage door opener with the rolling code feature, follow these instructions after the transceiver has been programmed (the aid of a second person may make the training quicker and easier):

1. Locate the training button on the *garage door opener motor head unit*. The exact location and color of the button may vary. If you encounter difficulty, refer to the garage door opener owner's manual or call: 1-800-355-3515 (Internet: www.HomeLink.jci.com).
2. Press the "training" button on the garage door opener motor head unit until the "training" light comes on.
3. Firmly press and release the programmed HomeLink® button. Press and release the HomeLink® button a *second* time to complete the training process.
Some garage door openers may require you to do this procedure a *third time* to complete the training.

The programmed button on your HomeLink® Universal Transceiver should now operate your garage door opener. The original hand-held transmitter can also be used, if necessary, to operate the garage door.

The remaining two buttons can be programmed in the same way. In the event of any problems in programming the HomeLink® Universal Transceiver, call 1-800-355-3515 (Internet: www.HomeLink.jci.com).

Operating the HomeLink® Universal Transceiver

Once programmed, the HomeLink® Universal Transceiver can be used in place of hand-held transmitters.

To operate, press the programmed HomeLink® button to activate the garage door, driveway gate, security lighting, home security system, etc.

The original hand-held transmitter can, of course, be used at any time.

Erasing programmed buttons

Individual buttons cannot be erased. To erase all three programmed buttons:

1. Hold down the two outside buttons on the HomeLink® Universal Transceiver until the indicator light begins to flash, after approximately 20 seconds.
2. Release both buttons.

The HomeLink® buttons can be reprogrammed using the procedures described on the previous page.

(HomeLink® information is continued on the next page)

pg. 200 HomeLink® Universal Transceiver (option)

Reprogramming a single HomeLink® button

1. Press and hold the desired HomeLink® button. **Do not release** the button until step 3 has been completed.
2. When the indicator light begins to flash slowly (after approximately 20 seconds), position the hand-held transmitter 2 to 5 in. (5 to 12 cm) away from the HomeLink® surface.
3. Press and hold the hand-held transmitter button.
The HomeLink® indicator light will begin to flash, first slowly then rapidly. When the indicator light flashes rapidly, release both buttons.

The previously programmed device has now been erased and the new device can be activated by pressing the HomeLink® button that has just been programmed. This procedure will not affect any other programmed HomeLink® buttons.

NOTE:

- Retain the original transmitter(s) for future programming procedures (i.e., if you purchase a new car).
- It is also suggested that if you sell your car, the programmed channels on the HomeLink® Universal Transceiver be erased for security purposes.



[Contents](#) | [Top of Page](#)

2000 VOLVO S & V70

Index

pg. 201 Index

A

ABS	21,23,83
Accessories - installing	107
Adjustable steering wheel	36
Adjusting headlights	98
Air conditioning	38,39,41
Air mix	37
Air vents	37
Airbag (SIPS)	8
Airbag (SRS)	4
Alarm	47
All Wheel Drive (AWD)	77,122
changing wheels	95
snow chains	89
towing	81
wheel dimension caution	88
Ambient temperature sensor	29
Anti-lock Brake System (ABS)	21,23,83
Antifreeze	85,130
Ashtrays	35
Audio systems	
General information	194
SC-813	142

SC-816	155
SC-900/901	171
Automatic car washing	115
Automatic daytime running	28
Automatic transmission	73,74,75,76,77,137
Kickdown	74,76
Automatic transmission fluid	134
Auxiliary seat	12
Auxiliary socket	35
B	
Battery	85,138
Battery drain - avoiding	62
Battery maintenance	132
Booster cushion	10,
Brake failure warning light	21,22
Brake fluid	128,134
Brake fluid warning light	22
Brake system	83,84
Bulb failure warning	23
Bulb failure warning light	21
Bulbs	138
Bumper cover	62
C	
Capacities	137
Cargo eyelets	64
Cargo net - side	63
Cargo space lighting (wagon)	58
Center head restraint	3
Central locking button	45
Chains - winter driving	89
Changing a wheel	94
Child auxiliary seat (wagon)	12

Child booster cushion	10,15
Child Restraint Anchorages	14
Child safety	15
Child safety locks - rear doors	50
Clock	20
Clock - resetting	29
Clutch fluid	128
Clutch interlock	72
Concealed storage bin (wagon)	62
Coolant - checking/changing	130
Coolant level sensor	23
Coolant level warning light	21
Cooling system	78,136
Courtesy lights - exterior	24
Cross bars (AWD XC)	79
Cruise control	33
D	
Daytime running lights	28
Demister - rear window	27
Dimensions	140
Diversity antenna	197
Doors and locks	45
Driving economy	70
Driving mode W	74,76
E	
EBD (Electronic Brake-force Distribution)	84
ECC - Electronic Climate Control	40,41
Electrical system	78,138
Electrically operated driver's seat	52
Electrically operated front seats	51,110
Electrically operated sun roof	54
Electrically operated windows	42,110

Electronic Brake Distribution (EBD)	84
Electronic Brake-force Distribution (EBD)	84
Emergency towing	80
Emergency warning flashers	27
Emissions systems	124
Engine	135
Engine compartment	131
Engine oil	127,134
Engine oil - checking/changing	126
Engine oil pressure	21
Exterior courtesy lights	24
F	
Fog light - rear	21,26
Fog lights - front	26
Folding front seat (sedans/wagons)	65
Folding rear seat (sedan)	59
Folding rear seat (wagon)	60,61
Four wheel drive	77,122
changing wheels	95
snow chains	89
towing	81
Front courtesy lights	53
Front seats	51
Front seats - heated	34
Front suspension	136
Fuel gauge	20
Fuel level	21
Fuel system	124,136
Fuel tank cover - opening	69
Fuses	104,105,106
G	
Gas tank cover - opening	69

Generator	21,138
Generator warning light	23
H	
Hand brake	34
Handling	79
Hazard warning flashers	27
Headlight adjustment	98
Headlight wiper blades - replacing	109
Headlights	24
Heated front seats	34
Heated side-view mirrors	27
Heating	38,39,41
Heating and air conditioning	37
High beams	21
HomeLink®	198,199,200
Hood	55
I	
Ignition switch	25
Immobilizer (start inhibitor)	44
Instrument illumination	26
Instruments	18,
Integrated booster cushion	10
J	
Jack (sedan)	57
Jack (wagon)	58
Jump starting	82
K	
Keyless entry system	46
Keylock	71
Keys	44
Kick-down	73,75
Kickdown	74,76

L

Label information	118
Lock button - tailgate	49
Locking button - central	45
Locks	45
Long load storage (sedans)	65
Lubrication	125
Luggage net - wagon	63
Lumbar support	51

M

Maintenance schedule	120
Maintenance service	119
Malfunction indicator lamp	21,22
Manual transmission	72,137
Manual transmission fluid	134
Memory function - front seats	51
Mirrors - rear/side view	52

O

Occupant safety	16
Octane rating	69
Odometer	20
Oil pressure warning light	22
On-call	140

P

Paint touchup	112
Parking brake	21,34
Parking brake reminder light	22
Parking lights	24
Polishing	115
Power seats	51,110
Power steering fluid	128,134
Power windows	42,110

R

Radio

SC-813 [142](#)

SC-816 [155](#)

SC-900/901 [171](#)

Radio Data System - RDS [176](#)

Rails (roof) [79](#)

Reading lights [53](#)

Rear fog light [21,26](#)

Rear suspension [136](#)

Rear window demister [27](#)

Rear/side-view mirrors [52](#)

Refueling [69](#)

Remote control (central locking system) [46](#)

Remote keyless entry system [46](#)

Removing seat cushions (wagon) [61](#)

Replacing bulbs [98,99,100,101,102,103](#)

Replacing fuses [104](#)

Reporting safety defects [16](#)

Road Assistance [140](#)

Roadholding [79](#)

Roof rails/racks [79](#)

S

Safety defects - reporting [16](#)

Safety locks - child [50](#)

Seat belt maintenance [16](#)

Seat belts [2,3,13](#)

Seat belts - cleaning [116](#)

Seats [51](#)

Securing cargo [64](#)

Service reminder indicator [21,23](#)

Servicing [122,123](#)

Shift lock	71
Shiftlock	73,75
Shiftlock release (override)	110
Side cargo net	63
Side Impact Protection System (SIPS)	8
Side-view mirrors - heated	27
SIPS	8
Snow chains	89
Snow tires	89
Spare tire	96
Spare tire (sedan)	57
Spare tire (wagon)	58
Spark plugs	136
Specifications	133
Spool-out (seat belt)	13
SRS	5,6,7
SRS diagnostic system	22
SRS warning light	5,21,22
Stability and Traction Control (STC)	21,23,27,84
Start inhibitor (immobilizer)	44
Starting the engine	71
Steering wheel adjustment	36
Steering wheel lock	25
Storage compartments	56
Studded tires	89
Sun roof	27,54,110
T	
Tachometer	20
Tailgate (opening/locking)	49
lock button	49
Tailgate wiper/washer	28
Temperature gauge	20

Temporary spare tire	96
Tire pressure	90
Tires	88
Tires - changing	94
Towing	80,81
Towing a trailer	86
Traction Control System (TRACS)	21,23,27,84
Trailer towing	86
Trip computer	27,30,31,32
Trip odometer	20
Trunk (opening/locking)	49
Trunk light	57
Turn signals	21,24
U	
Uniform tire quality grading	91
Upholstery - cleaning	116
V	
Vanity mirrors	53
Vehicle Identification Number (VIN)	118
Vehicle loading	137
Whiplash Protection System (WHIPS)	9
WHIPS	9
Winter/Wet driving mode	74,76
Volvo On Call	140
W	
Warning flashers	27
Warning lights	22,23
Warranty	119
Washer fluid level	21
Washer fluid reservoir	129
Washing	114
Waxing	115

Wheel changing	94,95
Wheels and tires	88
Windows - electrically-operated	42
Windshield washer nozzles	129
Windshield wiper blades - replacing	108
Winter driving	85



[Contents](#) | [Top of Page](#)

2000 VOLVO S & V70

Back Cover

WARNING!

Detergents and solvents

Do not use gasoline containing lead or benzene as a detergent or solvent. Both lead and benzene are toxic and may be hazardous to your health.

Installation of optional equipment/use of mobile telephones

Incorrectly installed optional equipment, alarm systems or the use of mobile telephones which are not connected to a suitable antenna can cause faults in the car's electronic control systems. Your car is equipped with an accessory connector located under the dashboard on the driver's side. Please consult your Volvo retailer if you have any questions before connecting accessory or optional equipment to the vehicle's electrical system.

Carbon monoxide

Carbon monoxide is a poisonous, colorless and odorless gas which is present in all exhaust gases. If you ever smell exhaust fumes inside the vehicle, make sure the passenger compartment is ventilated and immediately return the vehicle to your retailer for correction.

Never sit in a parked or stopped car for any extended amount of time, nor have it unattended while the engine is running.

Never operate the engine in confined, unventilated areas.

The following should be checked regularly: *

1 Washer fluid reservoir should be filled with water and solvent (wintertime: windshield washer anti-freeze). See [page 129](#).

2 Coolant level should be between the expansion tank marks. Mixture: 50% anti-freeze and 50% water. See [page 130](#).

3 Power steering - When cold, the level must not be above the COLD mark and when hot it must not be above the HOT mark. Top up if the level drops to the ADD mark with ATF fluid. See [page 128](#).

4 Engine oil level should be between the dipstick marks. The distance between the marks represents approx. 1.6 US qts (1.5 liters). See [page 126](#).

5 Brake fluid - check, without removing the cap, that the level is above the MIN mark. Use brake fluid DOT 4+. See [page 128](#).

* Engine oil should be checked each time the car is refuelled.

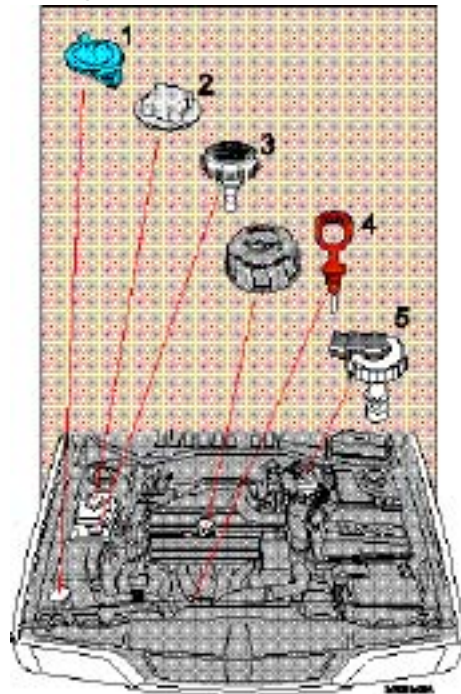

Octane rating, see [page 67](#)

Tire pressure, see label located on inside of fuel filler flap.

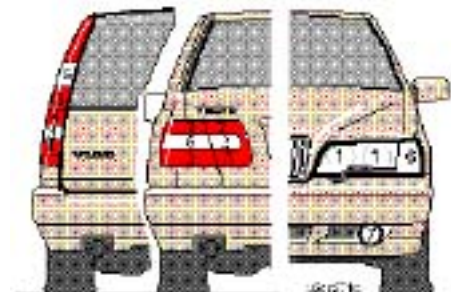

Bulbs	Power	Socket	US no.
1	55 W	-	H7
2	5 W	BA 15s	67
3	21 W	BA 15s	1156
4	21/4 W	BAZ 15d	-
5	21 W	BAU 15s	-
6	26/7 W	W2.5x15q	3357NA
7	55 W	-	H1

See [pages 95-101](#) for more detailed information.

Volvo Car Corporation

Göteborg, Sweden



[Contents](#) | [Top of Page](#)